

Crowcon XgardIQ

Intelligent Gas Detector and Transmitter



Installation, operating and maintenance instructions

M070030

Issue 3: June 18

Contents

1. Introduction.....	1
1.1 Crowcon XgardIQ concept.....	1
1.2 Safety information.....	2
1.3 Storage instructions.....	2
1.4 Model configuration.....	3
1.4.1 Product Options.....	3
1.4.1.1. Relay Module.....	3
1.4.1.2. HART Communications.....	4
1.4.1.3. Sensor Modules.....	4
1.5 Certification labels.....	5
1.6 Product dimensions.....	7
2. Installation.....	8
WARNING.....	8
2.1 Location.....	9
2.2 XgardIQ Transmitter Mounting.....	10
2.2.1 Mounting to a flat surface.....	10
2.2.2 Mounting to a pipe.....	11
2.3 Remote sensor housing mounting and cabling.....	12
2.3.1 Required accessories:.....	12
2.4 Fitting accessories.....	13
2.4.1 Calibration cap (part number S012323).....	13
2.4.2 Calibration station (part number S012343).....	13
2.4.3 Splash guard (part number S012322).....	13
2.4.4 Flow adaptor (part number: S012324).....	13
2.4.5 Dust filter (part number S012321).....	13
2.4.6 Dummy sensor module (part number S012335).....	13
2.4.7 Pipe mounting kit (part number: C01001).....	13
2.4.8 Collector Cone (part number: S012340).....	14
2.4.9 Sun Shade (part number: S012339).....	14
2.4.10 Duct mounting kit (part number: C01894).....	14
2.4.11 PC communications leads.....	14
2.4.12 Sensor module removal tool (part number: C02186).....	14
2.5 Cabling requirements.....	15
2.5.1 Earthing requirements.....	15
2.5.2 Cable Connections.....	16
2.5.2.1. 4-20mA Analogue connection.....	17
2.5.2.2. Stand-alone operation and Analogue Output Simulation.....	17
2.5.3 Relay connections.....	18
2.5.4 HART Communication Connections.....	18

3. Operation	19
3.1 General.....	19
3.2 Display module.....	19
3.3 +ve Safety™.....	20
3.4 Start up	20
3.5 Checking status and configuration.....	22
3.5.1 Information screen	22
3.5.1.1. About	22
<i>Identification</i>	<i>22</i>
<i>Firmware</i>	<i>22</i>
<i>Fitted Modules.....</i>	<i>23</i>
<i>Serial Number.....</i>	<i>23</i>
<i>Sensor</i>	<i>23</i>
3.5.1.2. Readings.....	23
<i>Temperature</i>	<i>23</i>
<i>Supply Voltage.....</i>	<i>23</i>
<i>Signal Feedback.....</i>	<i>23</i>
<i>Peak Gas</i>	<i>24</i>
<i>Peak Temperature.....</i>	<i>24</i>
3.5.1.3. Date and Time	24
<i>Current.....</i>	<i>24</i>
<i>Due Dates.....</i>	<i>24</i>
<i>On Time</i>	<i>25</i>
3.5.1.4. Status	25
3.5.1.5. +ve Safety™	25
3.5.1.6. Sensitivity	25
3.5.2 Main menu.....	26
3.5.2.1. Zero	26
3.5.2.2. Calibrate.....	27
3.5.2.3. Pellistor Sensor Cross-Calibration.....	28
3.5.2.4. Inhibit.....	30
3.5.2.5. Change Sensor.....	31
3.5.2.6. Test.....	32
<i>Analogue Output.....</i>	<i>32</i>
<i>Bump Test</i>	<i>33</i>
<i>Display.....</i>	<i>35</i>
<i>Relay</i>	<i>35</i>
<i>Watchdog</i>	<i>35</i>
3.5.2.7. Configure.....	36
<i>Analogue Output.....</i>	<i>36</i>
<i>Alarm and Relay</i>	<i>39</i>
3.5.2.8. Information.....	46
3.5.2.9. Event log.....	47

3.6	Menu functions	48
3.6.1	Information menu structure	48
3.6.2	Main Menu structure	49
3.7	Commissioning	50
3.7.1	Applying Power	50
3.7.2	Sensor Zero	50
3.7.3	Sensor Calibration	51
3.7.4	Other Commissioning Checks	51
3.8	Routine maintenance	52
3.9	Bump Test and Calibration Due Function	53
3.10	Changing sensor modules	54
3.11	Alarm Mode	55
3.11.1	Alarm settings	55
3.12	Pellistor saver mode	56
3.13	Operating parameters	56
4.	Specification	57
5.	Spare parts	59
5.1	XgardIQ Spares	59
6.	Fault finding	60
6.1	General	60
6.2	+ve Safety™	60
6.3	Information	61
6.4	Warnings	64
6.5	Faults	66
6.6	Status LED	72
6.7	Analogue Output	73
6.8	Analogue Output Simulation	73
6.9	Data retention	73
6.9.1	Default settings	73
7.	RS485 Modbus configuration	74
7.1	General	74
7.2	Wiring topology	76
7.2.1	Star connection	76
7.2.2	Bus connection	76
7.3	Cabling requirements	77
7.3.1	Calculating the minimum level of power required	77
7.3.2	Sample calculation	78
8.	HART Communications	79
8.1	Overview	79
8.2	Local hand-held HART communicator connection	79
8.3	HART over the 4-20mA signal line	80
8.4	XgardIQ transmitters multi-dropped on a HART addressable network	80

8.5 Functions available via HART	81
9. Functional Safety Manual	82
9.1 Introduction	82
9.2 XgardIQ Safety Function	82
9.3 Diagnostic Interval	82
9.4 Constraints.....	82
9.5 Fault indication whilst in Inhibit mode	83
Warranty	84

1. Introduction

1.1 Crowcon XgardIQ concept

The **Crowcon XgardIQ** is an intelligent and versatile gas detector and transmitter compatible with **Crowcon's** full range of sensor technologies. **XgardIQ** incorporates a bright OLED (Organic Light Emitting Diode) display with clear and comprehensive status information in a range of languages and is available fitted with the following sensor module types:

- Toxic
- Oxygen
- Pellistor
- Infrared (IR)

XgardIQ can also be installed with a remote sensor housing, having a range of up to 15 metres from the transmitter.

Providing analogue 4-20mA signal and RS-485 Modbus signals as standard (see Section 7), **XgardIQ** is optionally available with Alarm and Fault relays and HART communications.

Alarm and fault relays featuring heavy-duty changeover contacts rated 230Vac 5A are available at purchase, or may be added at any time after installation.

HART communications can be provided both over the analogue signal and via local I.S. terminals for diagnostics via any HART asset management system or hand-held device.

The 316 stainless steel enclosure is available with three M20 or ½" NPT cable entries.

Where **XgardIQ** is to be installed potentially months ahead of scheduled commissioning, it can be supplied without a sensor module. This avoids the possibility of the sensor being poisoned or expiring whilst inactive. The **XgardIQ** transmitter is supplied with a dummy sensor module to maintain dust and water ingress protection, the required sensor module may then be delivered for installation during commissioning.

ATEX and IECEx certified for use in Zone 1 and Zone 2 hazardous areas, **XgardIQ** has been designed for long-life operation in extreme environments. Offering rugged construction and a wide operating temperature range from -40°C to +75°C (depending on sensor type), **XgardIQ** is suitable for the most demanding applications.

For further information about accessories for the **XgardIQ** see Section 2.4 on page 13 and for spare parts, see Section 5, page 59.

1.2 Safety information

XgardIQ gas detectors must be installed, operated and maintained in strict accordance with these instructions, warnings, label information, and within the limitations stated.

- The circular lid on **XgardIQ** must be kept tightly closed with the grub-screw secured during operation. Do not attempt to remove the lid until power to the transmitter is isolated - otherwise ignition of a flammable atmosphere can occur. Before removing the lid for installation or maintenance, check that the surrounding atmosphere is free of flammable gases or vapours. Do not open until several minutes after the power has been removed. The sensor module is Intrinsically Safe and therefore may be safely removed in the hazardous area whilst power is applied to the transmitter.
- Maintenance and calibration operations must only be performed by qualified service personnel.
- Only genuine **Crowcon** replacement parts must be used; substitute components may invalidate the certification and warranty of the **XgardIQ**.
- **XgardIQ** must be protected from extreme vibration, and direct sunlight in hot environments as this may cause the temperature of the **XgardIQ** to rise above its specified limits and cause premature failure.
- The enclosure must be electrically bonded to earth using the lug provided adjacent to the top-left cable entry.
- The detector must be installed in an area where there is a low risk of mechanical damage.
- The gland entry stopping (blanking) plugs supplied fitted to **XgardIQ** are certified for use in a hazardous area only when used with this product.
- Unused cable entries must be sealed using the originally supplied stopping plugs or an ATEX / IECEx Ex d flameproof equipment appropriately certified alternative.
- Cable entry devices and threaded adapters fitted shall be suitable for the equipment, the cable and the conditions of use, and shall be IECEx / ATEX flameproof certified as Ex equipment, and not an Ex component.
- Local procedures and regulations must be followed.
- **Warning:** transmitters fitted with relay modules may be used for switching mains voltages. Extreme care must be taken when removing the lid and making connections. Mains power connected to the relay contacts (and associated devices) must be isolated before attempting maintenance work on **XgardIQ**.
- Refer to section 3.13 when making configuration changes.

1.3 Storage instructions

Some types of sensor available with **XgardIQ** have limited life when left un-powered and/or may be adversely affected by temperature extremes or environmental contamination. Please refer to the information sheet supplied with the sensor module for specific instructions.

1.4 Model configuration

The configuration of each **XgardIQ** is identified by a label fitted on the main body. Please quote the product name, product code and serial number when contacting **Crowcon** for advice or spares.

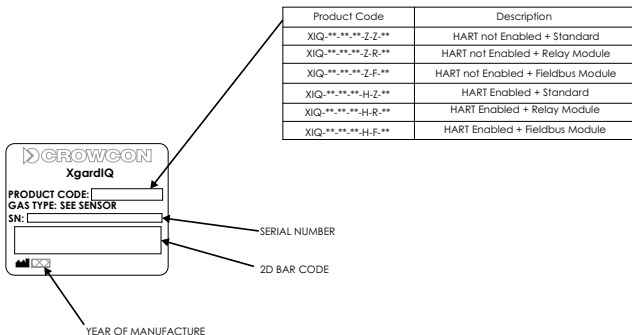

Diagram 1: XgardIQ Model / Serial Number Label

1.4.1 Product Options

1.4.1.1. Relay Module

XgardIQ can optionally be fitted with a relay module containing Alarm 1, Alarm 2 and Fault relays for switching local alarms, valves etc. The relay module may be fitted at the time of order, or retro-fitted at any point. To fit a relay module, isolate power from the transmitter and plug the module in to the allotted space (see Diagram 3). The relay module will be recognized and configured when power is re-applied.

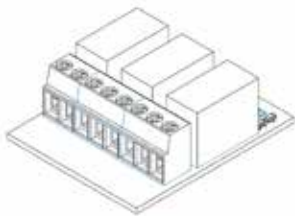

Diagram 2: Relay Module

1.4.1.2. HART Communications

HART communications can be provided both over the analogue signal and via local I.S. terminals for diagnostics using any HART asset management system or hand-held device.

Note: the HART option must be specified at the time of order and cannot be retro-fitted to an XgardIQ transmitter.

Relay and HART enabled detectors can be identified by the detector product code and also by accessing the **Information/About/Fitted Modules** screen on the **XgardIQ** display (refer to Fitted Modules on page 23).

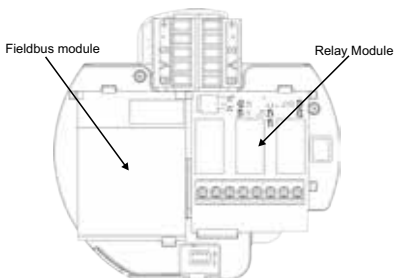

Diagram 3: Relay module and space/connector for the Foundation Fieldbus module

1.4.1.3. Sensor Modules

XgardIQ is available with a sensor module, a remote sensor housing (enabling the sensor to be mounted up to 15 metres from the transmitter) or without a sensor module.

Option 1 with sensor module: The sensor module will be fully calibrated and tested and packed in its own carton with the XgardIQ transmitter. The transmitter will upload the appropriate configuration from the sensor module when it is first inserted.

Option 2 remote sensor housing: the transmitter and sensor module will be configured and shipped as described above. The sensor module can then be installed into the remote sensor housing ordered with the detector.

Option 3 without a sensor module: where the **XgardIQ** is to be installed potentially months ahead of scheduled commissioning, it can be supplied without a sensor module. This avoids the possibility of the sensor being poisoned or expiring whilst inactive. Pre-calibrated sensor modules can be delivered and installed prior to commissioning; the transmitter will read the correct configuration from the sensor module on insertion.

1.5 Certification labels

XgardIQ is an intelligent and versatile gas detector and transmitter compatible with **Crowcon's** full range of sensor technologies.

XgardIQ features an Exd flameproof electronics/terminal area fitted with an individual Galvanic Isolator that provides an Intrinsically Safe interface to the display module and sensor module. The product is then certified Ex db ia and is suitable for use in ATEX/IECEX Zone 1 and Zone 2 hazardous areas.

Note: if no certification label is fitted to the XgardIQ, the detector is not certified for use in hazardous areas.



Diagram 4: XgardIQ certification label



Diagram 5: XgardIQ warning label

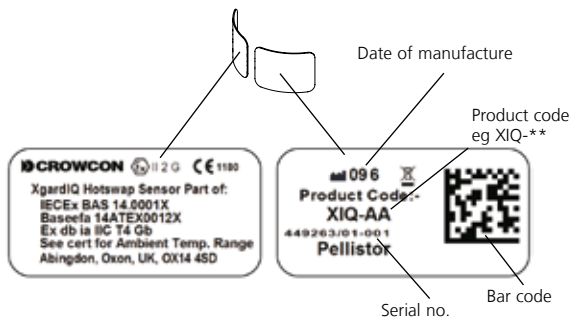

Diagram 6: Sensor module labels



Diagram 7: Remote sensor module label

1.6 Product dimensions

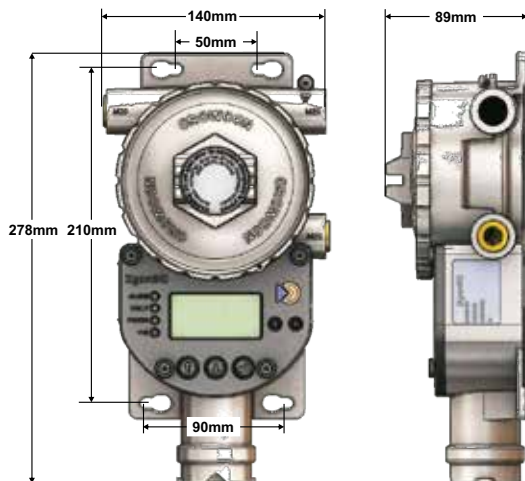

Diagram 8: XgardIQ dimensions

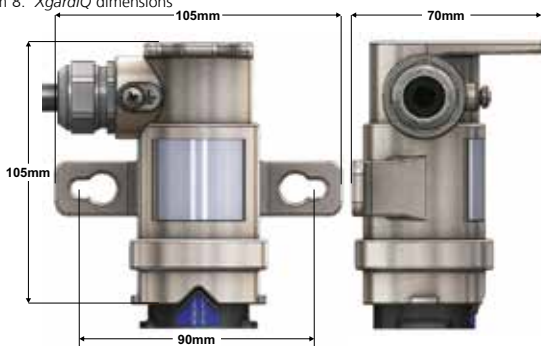

Diagram 9: Remote sensor housing dimensions

2. Installation

WARNING

- XgardIQ is ATEX and IECEx certified for use in Zone 1 and Zone 2 hazardous areas. Two protection concepts have been deployed in its design: Flameproof (Exd) and Intrinsic Safety (Exia) delivering an overall certification code: Exd db ia.

Although the design incorporates Intrinsically Safe (Exia) elements (ie the display module and sensor modules), the overall concept is essentially Flameproof (Exd) and therefore XgardIQ cannot be used in Zone 0 applications as a purely Exia product could be.

An I.S. isolating circuit designed by Crowcon is incorporated onto the circuits housed within the Exd section of the XgardIQ transmitter enclosure. This provides the necessary protection to the I.S. elements of the product.

XgardIQ cannot and must not be connected to a control system via an I.S. barrier such as a Zener Barrier or Galvanic Isolator.

Please refer to the specifications table on page 42 for certification details. Installation must be in accordance with the recognized standards of the appropriate authority in the country concerned.

Warning: a dummy sensor module must be fitted to the XgardIQ transmitter to maintain ingress protection if installation is conducted significantly ahead of commissioning.

- For further information please contact Crowcon. Prior to carrying out any installation work ensure local regulations and site procedures are followed.
- The equipment must be earthed using the cable gland and steel armoured cable.

2.1 Location

The **XgardIQ** or, where applicable, the remote sensor housing, should be mounted where the gas to be detected is most likely to be present. The following points should be noted when locating gas detectors:

- To detect gases which are lighter than air, such as methane, sensors should be mounted at high level. To detect heavier-than-air gases, such as flammable vapours, sensors should be mounted at low level.
- When locating detectors consider the possible damage caused by natural events e.g. rain or flooding. For detectors mounted outdoors in very hot regions **Crowcon** recommend the use of a sun shade (see Section 2.4.9, Sun Shade (part number: S012339), on page 14).
- Consider ease of access for functional testing and servicing.
- Consider how the escaping gas may behave due to natural or forced air currents. Mount **XgardIQ** in ventilation ducts if appropriate (see Section 2.4.10, Duct mounting kit (part number: C01894), on page 14).
- Consider the process conditions. For example, butane is normally heavier than air, but if released from a process which is at an elevated temperature and/or pressure, the gas may rise rather than fall.
- Location of oxygen sensors requires knowledge of the gas that may displace the oxygen. For example, carbon dioxide is denser than air and therefore is likely to displace oxygen from low levels upwards.
- Sensors should be mounted at head height (1.5m nominally) to detect gases of a similar density to air, assuming that ambient conditions and the temperature of the target gas are nominally 20°C.

2.2 XgardIQ Transmitter Mounting

The **XgardIQ** transmitter can be mounted in two ways:

- To a flat surface using M6 fixings suitable for the wall/surface type.
- To a pole of up to 60mm in diameter using the Pipe Mounting Kit accessory.

Note: the transmitter must be mounted with the sensor (if directly fitted) pointing downwards. This ensures that dust and/or water will not collect on the sensor and potentially prevent gas from being detected.

2.2.1 Mounting to a flat surface



Diagram 10: Mounting to a flat surface

Mount using 4x M6 fixings suitable for the wall surface.

2.2.2 Mounting to a pipe

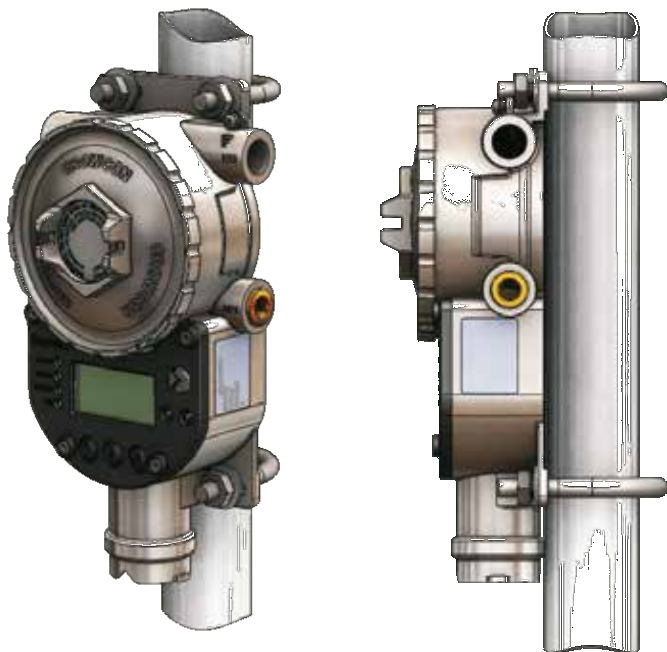

Diagram 11: Mounting to a pipe

Mount using the Pipe Mounting Kit accessory (part number C01001). Ensure the supplied washers are correctly fitted and the nuts are tightly secured. Maximum pipe thickness: 60mm.

2.3 Remote sensor housing mounting and cabling

The **XgardIQ** sensor module can be mounted up to 15 metres from the transmitter to enable the sensor to be installed in the ideal location for sensing the gas, whilst keeping the transmitter at a level that can easily be viewed and operated by maintenance personnel. The remote sensor housing has holes and lugs for wall or ceiling mounting



Diagram 12: Remote sensor housing installation

2.3.1 Required accessories:

Remote sensor housing and cable assembly of the appropriate length:

5 metres (part number S012325)

15 metres (part number S012331)

Note: remote sensor housing and cable assemblies are supplied with a cable retaining cap which must be fitted as shown in Diagram 13. The assembly cable must not be cut or modified in any way



Diagram 13: Fitting the cable retaining cap

The remote sensor lead plugs into the **XgardIQ** transmitter sensor module port. The cable retaining cap must be fitted to ensure that the sensor lead cannot be accidentally pulled-out.

2.4 Fitting accessories

2.4.1 Calibration cap (part number S012323)

Clips to the **XgardIQ** transmitter or remote sensor housing for application of calibration/bump test gas from a suitably regulated cylinder.



An exhaust tube may be connected if required up to a maximum length of 30 metres

Warning: this accessory must be removed after the bump test/calibration is complete.

2.4.2 Calibration station (part number S012343)

Surface mounted accessory to enable calibration of an **XgardIQ** sensor module on a work-bench. An exhaust tube may be connected if required up to a maximum length of 30 metres.



2.4.3 Splash guard (part number S012322)

Clips to the **XgardIQ** transmitter or remote sensor housing. For outdoor installations and sensor protection from water sprays. Includes a pipe spigot for performing a Speedy Bump test in indoor applications where the local air-flow speed is less than 1 metre per second. A test gas flow-rate of 1-3 litres per minute is recommended depending on pipe length.



2.4.4 Flow adaptor (part number: S012324)

Clips to the **XgardIQ** transmitter for gas sampling applications.



2.4.5 Dust filter (part number S012321)

Self-adhesive filter; fits within a recess on the **XgardIQ** sensor module to protect the sensor in very dusty environments.



Warning: if a dust filter is to be used, the sensor must be calibrated with the filter in place. The filter must be inspected regularly and checked by conducting a bump-test to ensure it does not become blocked and prevent gas from reaching the sensor. The filter must be replaced if contamination is present or if a successful bump test cannot be performed. The dust filter will affect the response time of the sensor: refer to the sensor module datasheet for details.

2.4.6 Dummy sensor module (part number S012335)

Maintains IP rating of the **XgardIQ** transmitter when no sensor module is installed.



2.4.7 Pipe mounting kit (part number: C01001)

Stainless steel u-bolts, nuts and washers to enable **XgardIQ** to be rigidly mounted to a pipe of up to 60mm diameter.



2.4.8 Collector Cone (part number: S012340)

Clips to the **XgardIQ** remote sensor housing to aid detection of lighter than air gases such as hydrogen or methane. Includes a pipe spigot for application of bump test gas.



2.4.9 Sun Shade (part number: S012339)

Protects the detector from elevated temperatures due to direct sunlight.



2.4.10 Duct mounting kit (part number: C01894)

For ducts between 300mm and 3m wide, air-flows from 4 to 20m/s.



Note: this accessory must only be used in conjunction with the remote sensor housing.

2.4.11 PC communications leads

USB leads enable configuration of the **XgardIQ** transmitter or sensor modules via a Windows PC. Detectors Pro software is available for download from the Crowcon website. These leads are not suitable for use in a hazardous area.

E070045 **XgardIQ** transmitter PC comms cable.

C02187 **XgardIQ** sensor module PC comms cable.



2.4.12 Sensor module removal tool (part number: C02186)

For removing the sensor module. Insert the tool and lever downwards to release the module from its connector.



2.5 Cabling requirements

Cabling to **XgardIQ** must be in accordance with the recognised standards of the appropriate authority in the country concerned and meet the electrical requirements of the **XgardIQ**.

Crowcon recommends the use of steel wire armoured (SWA) cable and suitable explosion proof glands must be used. Alternative cabling techniques, such as steel conduit, may be acceptable provided appropriate standards are met. To maintain the ingress protection of the transmitter, only cable glands rated IP66 or higher must be used. The threads of the cable gland must be sealed using PTFE tape. If the stopping plugs fitted to spare enclosure entries are removed and re-fitted; a new layer of PTFE tape must be applied to the threads.

Crowcon strongly recommends that screened cables are used to prevent the risk of signal interference. Refer to the following section for earthing requirements.

The maximum recommended cable length is 1 km when using a cable with 2.5mm² conductors (see Table 1). The calculations shown assume the highest power sensor type is used and a relay module is fitted. Actual maximum cable length will increase for **XgardIQ** transmitters fitted with lower power (eg electrochemical) sensors and where relays are not fitted.

XgardIQ requires a dc supply of 14-30V DC. Ensure there is a minimum of 14V at the **XgardIQ** from the control panel, taking into account the voltage drop due to cable resistance at a peak current of 0.25A. The following calculations assume a guaranteed minimum supply of 20Vdc from the control system.

Table 1 below shows the maximum cable distances for typical cable parameters.

C.S.A.	Resistance	Max. Distance >20 Vdc*
mm ²	(Ohms per km)	(km)
1.0	18.4	0.65
1.5	13.0	0.9
2.5	11.5	1.0

* Minimum supply voltage from control panel

Table 1: Maximum cable distances for typical cables

Note: *Crowcon strongly recommends the use of screened cables to prevent potential signal interference.*

2.5.1 Earthing requirements

Earth terminals are provided on the outside of the **XgardIQ** enclosure adjacent to the top-right cable entry, and internally near the right-hand field cable connector. For electrical safety it is essential that the **XgardIQ** enclosure is bonded to earth, usually using the external earth lug, if an earth cable is provided in the field cable the internal earth point can be used.

2.5.2.1. 4-20mA Analogue connection

In this operating mode **XgardIQ** is connected to a controller via a 3-core cable. The +ve (24V nominal) supply connects to terminal 1, the -ve core connects to terminal 2 and the Signal core connects to terminal 3. Care must be taken to ensure the cables are correctly connected before applying power.

Note: Crowcon strongly recommends the use of screened cables to prevent potential signal interference. The cable screen should be connected to earth at the control panel only (not within the XgardIQ transmitter).

XgardIQ features a unique auto-sense function: it automatically detects whether the control system is configured as 4-20mA current Sink or Source and sets itself appropriately. If necessary **XgardIQ** can be manually set to Sink or Source using the **Configure/Analogue Output/Mode** menu (refer to page 38).

2.5.2.2. Stand-alone operation and Analogue Output Simulation

The following instructions enable the **XgardIQ** transmitter to be operated in a healthy state without the analogue output connected to a control system. This is ideal for operating the transmitter in stand-alone mode, or to test a transmitter without it displaying an 'analogue output feedback fault'.

Before applying power, connect a wire-link between the -ve and Sig terminals (terminals 2 and 3). Connect a 24Vdc supply to the +V and -ve terminals (terminals 1 and 2) and check for correct operation. If an 'Analogue output feedback fault' is displayed check the Mode is set as 'Auto Sense' (see page 38).

2.5.3 Relay connections

XgardIQ may optionally be fitted with a relay module which provides volt-free contacts rated 5A 230Vac maximum. These relays can be used for switching local alarm devices, valves etc. Alarm 1, Alarm 2 and Fault relays are provided; refer to page 39 for relay configuration. Relay module contact connections are shown below, the bottom-right-hand cable entry can be used for connecting local device cables to the relay module (the factory-fitted stopping plug must be removed first and a suitably certified Exd cable gland must be used).

Note: when switching mains voltages, in order to avoid problems due to electrical interference, do not run AC cables from relay contacts in the same conduit or cable tray as the DC supply or signal cable.

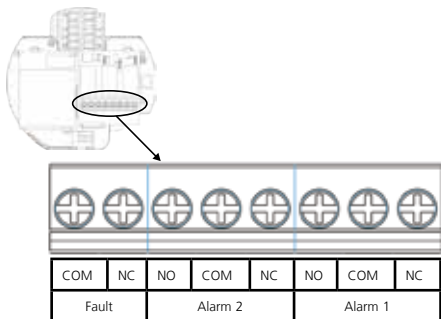

Diagram 15: Relay module with connections shown

Note: Relay contacts shown in de-energized state.

RS-485 Modbus Connections

Refer to Section 7 for connection and operation details.

2.5.4 HART Communication Connections

Refer to Section 8 for connection and operation details.

Note: comprehensive instructions for connecting to, and communicating with detectors using the HART or Modbus protocols are provided in the following documents:

- M071023 **XgardIQ** Modbus Instructions
- M071024 **XgardIQ** HART Instructions

3.1 General

The following section describes how to operate, maintain and configure an **XgardIQ** transmitter via the OLED display. There are two separate menus: a status/information menu that is accessible without a password (see Section 3.5.1), and a calibration/configuration menu that is protected by a password (see Section 3.5.2). Configuration changes should only be made by suitably trained and qualified personnel. Refer to section 3.13 when making configuration changes.

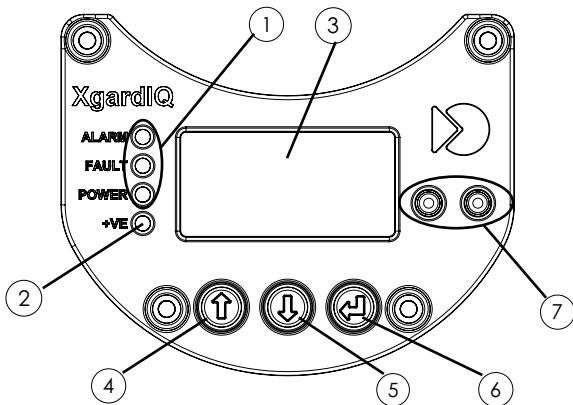

3.2 Display module

- ① Status LEDs
- ② +ve Safety™ indicator
- ③ Gas level, detector status and operator function display
- ④ Menu up key
- ⑤ Menu down key
- ⑥ Select/Enter/Reset key
- ⑦ I.S. (Intrinsically Safe) HART terminals

Diagram 16: Control panel

3.3 +ve Safety™

Crowcon's unique '+ve Safety' function confirms the detector is operating safely and alerts operators to any irregular events that may affect product integrity such as the ambient temperature or gas levels exceeding sensor limits. When the detector is working safely the bright blue +ve Safety LED remains on constantly. If any abnormal operating conditions are detected (that don't necessarily constitute an immediate detector fault) the +ve Safety LED will flash and a warning message will be displayed.

For more information see Section 6 Fault finding.

3.4 Start up

When the **XgardIQ** is powered up, the unit will perform internal diagnostic checks whilst the display will show animated graphics to enable the user to identify any problems with the screen (pixel dropout, etc.). When these checks have been completed, the following information screens will be displayed for about 5 seconds each:



Diagram 17: Start up information screens

If the diagnostic checks were successful, the gas status screen will be displayed:

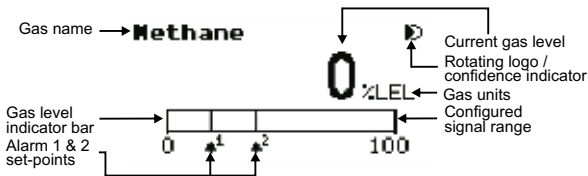

Diagram 18: Gas status screen

Note: The screen examples shown are for an XgardIQ fitted with a methane sensor. Other sensors will cause different screens to be displayed.

Note: a stabilisation time is applied to allow sensors to settle after being powered-up. During this time period the current gas level display will be replaced by an hour-glass symbol and a ! symbol will appear adjacent to menu functions such as Zero, Calibrate, Inhibit to indicate that they cannot be accessed. The stabilisation time varies according to sensor type. Refer to the datasheet supplied with the sensor module for details of specific stabilisation times.

In normal operation:

- The gas level will be indicated by the numeric display, and also by the gas level indicator bar.
- The rotating logo/confidence indicator is active to demonstrate that the detector is functioning.
- The green Power LED is illuminated in a steady state, blinking off once every four seconds to demonstrate that the detector is functioning.
- The blue +ve Safety LED is illuminated in a steady state to indicate that the detector is operating safely.

Note: the analogue output signal will become active approximately five seconds after power is applied to the transmitter. The signal will initially be at the level configured in the 'Power-on Inhibit' menu: 1mA, 2mA, 3mA or Clean Air (4mA for most sensors, 17.4mA for oxygen sensors). See page 38 for details.

The analogue output will commence representing the sensor signal from approximately 30-60 seconds from initial power-up. Some sensors need a longer time period to stabilise after-power-up and thus this initial start-up time will depend on the default time programmed within the sensor module. Contact **Crowcon** for advice on individual sensor stabilisation periods.

If the **XgardIQ** transmitter has been in storage or transit for a long time period the 'super-cap' that maintains the current date and time is likely to have discharged and the display will show **Time/date lost error** when first powered-up. See page 44 for instructions on re-setting the date and time.

- ▶ If the diagnostic tests are not successful, an error screen will be displayed. For information refer to Section 6: Fault finding
- ▶ Make a note of the error message (or take steps to rectify the error - refer to Section 6: Fault finding) and then press the  key to remove the error message. If there is more than one error message, the next error message will be displayed.

Operation

3.5 Checking status and configuration





Configuration and status information is available from two separate menu's:

- Information screen (see below)
This menu gives the user access to the information regarding the current status of the **XgardIQ**.
- Main Menu (see Section 3.5.2 on page 26)
This password protected menu enables the user to test and configure the **XgardIQ**. It also gives the user access to more in-depth data than the Information screen.

Note: to jump directly to the top of a menu list, press and hold the Up key and then press the Select key.

All menu screens will time-out after 5 minutes if no key is pressed. The transmitter will automatically revert to the normal operating screen and the selected menu function will be deactivated.



3.5.1 Information screen

- ▶ The Information screen is accessed from the Main gas screen by holding down the  key.
- ▶ Press the  key until the  is adjacent to the required option and press the  key.



Note: The Back option will return you to the previous screen when the  key is pressed.

3.5.1.1. About

- ▶ Press the  key until the  is adjacent to the required option and press the  key.

Note: Press the  key to return to the About menu when you have viewed the selected information.

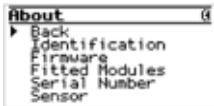

Identification

The user-set tag number or name for the transmitter will be displayed (— will be shown if none are set). The detector identification can be set using **Crowcon's** Detectors Pro software (see Section 2.4.11 on page 14 for details) or via a HART communicator.

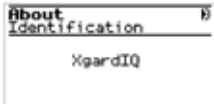

Firmware

This option displays the firmware versions for the main PCB, sensor module and display module.

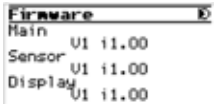

Fitted Modules

This option will indicate which, if any, optional modules are fitted to the **XgardIQ**.

If a module is present it will have a ✓ next to it or, if not, it will have a ✗ next to it.

Serial Number



This option displays the serial numbers of the Transmitter and the sensor module.

Sensor

This option displays the sensor type, its target gas and the maximum range of the sensor.

Note: the sensor range shown on the main operating screen may differ from the range shown on this screen. The operating range is user-selectable using the Range menu option, see page 37.

3.5.1.2. Readings

- ▶ Press the  key until the  is adjacent to the required option and press the  key.

Note: Press the  key to return to the Readings menu when you have viewed the selected information.

Temperature

This option displays the temperature of the transmitter and sensor.

Supply Voltage

This option displays the voltage being supplied to the **XgardIQ**.

Signal Feedback

This option displays the analogue output signal level currently being transmitted.

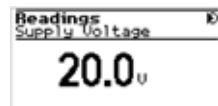
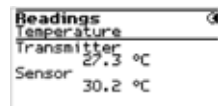
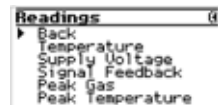
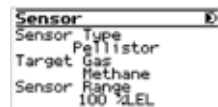
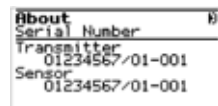
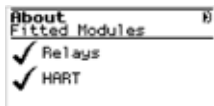

Peak Gas

This option displays the highest level of gas to which the sensor has been exposed since the transmitter was last power-cycled (**Since Power-On**) and since the sensor module was initially calibrated in the **Crowcon** factory (**Ever**).

This information is permanently stored within the sensor module (not the transmitter) and can be used for diagnostic purposes. For example unusually short sensor life may be due to a sensor module being exposed to extreme gas concentrations.

Readings	
Peak Gas	
Since Power-On	67 %LEL
Ever	88 %LEL



Peak Temperature

This option displays the highest ambient temperature to which sensor has been exposed since the transmitter was last power-cycled (**Since Power-On**) and since the sensor module was initially calibrated in the **Crowcon** factory (**Ever**).

This information is permanently stored within the sensor module (not the transmitter) and can be used for diagnostic purposes. For example unusually short sensor life may be due to a sensor module being exposed to extreme ambient temperatures.

Readings	
Peak Temperature	
Since Power-On	44.1 °C
Ever	47.2 °C

3.5.1.3. Date and Time

- ▶ Press the  key until the  is adjacent to the required option and press the  key.

Note: Press the  key to return to the **Date and Time** menu when you have viewed the selected information.

Date and Time	
▶ Back	
Current	
Due Dates	
On Time	

Current

This option displays the current date and time.

Date and Time	
Current	
16/APR/2014	
12:00:00	

Note: 'Current' date and time can be reset if necessary using the **Configure** menu. See page 44. The **XgardIQ** clock does not have automatic time adjustment for day-light saving (**DST**).

Due Dates

This option shows the dates when the next sensor Bump test and Calibration are due.

Due Dates	
Bump Test Due	
Now	
Calibration Due	

Note: Calibration and Bump test intervals are factory set within the sensor module and can only be modified using Crowcon's Detectors Pro software (see Section 2.4.11 on page 14 for details).

Calibration due dates are typically set to 180 day intervals, with the actual date calculated in the transmitter from the 'Current' time and date.

By default, the Bump test function is disabled and the due date shown on this screen will read "----". The Bump test function can be activated using **Crowcon's** Detectors Pro software (see Section 2.4.11 on page 14 for details) and bump test intervals are typically set to 90 days.

On Time

This option displays the total elapsed time since the transmitter was last power-cycled or when the last Watchdog test was performed (see page 35).

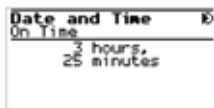

3.5.1.4. Status

The Status menu contains a list of unresolved Fault or Warning messages. If the amber Fault LED is active on the transmitter, but no error message is shown on the screen, use this menu to identify the cause(s). If no faults exist the screen will just display '> Back'. Multiple faults will be listed.

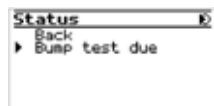

In the example opposite the fault status is 'Bump test due' and more detail (ie a status code) can be displayed by selecting the specific warning.

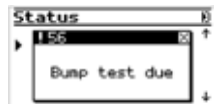

See Section 6 Fault finding for more information.

3.5.1.5. +ve Safety™

The +ve Safety menu contains a list of unresolved +ve Safety messages. If the blue LED is flashing on the transmitter, but no message is shown on the screen, use this menu to identify the cause(s). If no +ve Safety events exist the screen will just display '> Back'. Multiple +ve Safety events will be listed.

See Section 6 Fault finding for more information.

3.5.1.6. Sensitivity

The figure shown is calculated from the amplifier gain applied to the sensor signal at the last successful calibration. It may be used as an indicator of remaining sensor life (100% indicating that the sensor is performing as per the initial factory calibration).

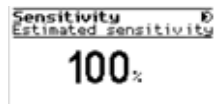





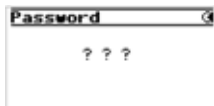

Operation

3.5.2 Main menu

The Main menu is accessed from the Main gas screen by holding down the  key. The password entry screen will be displayed.



- ▶ Press the following keys in sequence to enter the default password: , , . The Main menu will be displayed.
- ▶ Press the  key until the  is adjacent to the required option and press the  key.



Note: the Back option will return you to the previous screen when the  key is pressed.







Note: if an arrow is displayed to the right of the menu options, it indicates there are more options in the direction of the arrow.

Note; Zero and Calibration menu items are 'Wizard' controlled. Clear instructions will be displayed for every stage of the process; it is important to read the scrolling instruction messages before proceeding through each stage. The current stage of the process is shown in the bottom-right of the screen (eg 2/3 means the user is in the second stage of a three stage process).

3.5.2.1. Zero



Note: Purge sensor with the appropriate gas before zeroing.

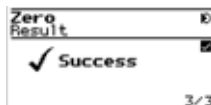
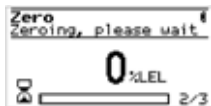
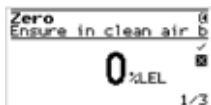

This function should only be carried out in 'clean air' and allows the XgardIQ to be zeroed at any time.



- ▶ To cancel the Zero function, press the  key so the  icon is flashing. Then press  to return to the Main menu.
- ▶ To carry out the zero function, ensure the  icon is flashing and press the  key. The zeroing screen will be displayed.
- ▶ When zeroing is complete a pass or fail screen will be displayed. Press  to return to the Main menu.







3.5.2.2. Calibrate

- ▶ With the  icon flashing, press . The calibration level screen will be displayed.

- ▶ To cancel the calibration, press the  key so the  icon is flashing and then press . The Main menu will be displayed.

- ▶ Adjust the value shown to match the calibration gas concentration by pressing the  key so the  icon is flashing then press .

Press the  and  keys to adjust the level to the required value then press .

The  icon will flash. Press  to accept the calibration level.

- ▶ Connect the calibration cap to the **XgardIQ** and then connect the appropriate gas cylinder to the adapter.

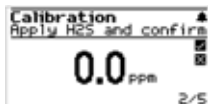
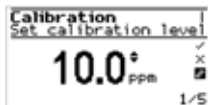
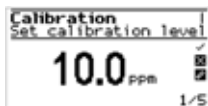



Operation

- ▶ When the gas flow is stable press the  key.
The calibration will begin.

When calibration is complete, remove the gas and calibration cap and wait for the gas level to return to normal before pressing the .

If the calibration was successful the  success symbol will be displayed.



- ▶ To return to the previous screen at any stage, press the  key so the  icon is flashing and then press .



Warning: the alarm inhibit state will be removed as soon as the Enter/Select/Reset key is pressed. Ensure the gas reading has dropped below the alarm thresholds and the Alarm LED has deactivated before confirming.

3.5.2.3. Pellistor Sensor Cross-Calibration

Pellistor sensor modules may be programmed with correction factors to enable alternative calibration gases to be used. This is useful where the target gas is not available or impractical to use.

When selecting the Calibration function the following screen will appear. The user can select to calibrate using the target gas (eg methane) or one of the alternatives listed (eg propane). The calibration gas must be applied in the concentration shown; correction factors are factory-set.

- ▶ Adjust the value shown to match the calibration gas concentration by pressing the  key so the  icon is flashing then press .

Press the  and  keys to adjust the level to the required value then press .

The  icon will flash. Press  to accept the calibration level.*

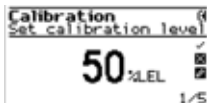
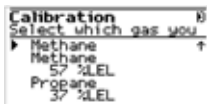
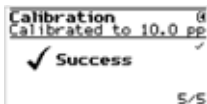
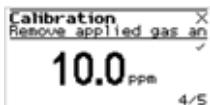
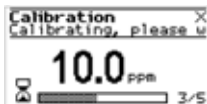

Once the gas type has been selected and the calibration level set, proceed as follows:

- ▶ Connect the calibration cap to the **XgardIQ** and then connect the appropriate gas cylinder to the adapter.

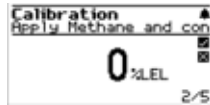





- ▶ When the gas flow is stable press the  key. The calibration will begin.

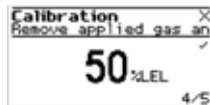

When calibration is complete, remove the gas and calibration cap and wait for the gas level to return to normal before pressing the  key.



If the calibration was successful the  success symbol will be displayed.

- ▶ To return to the previous screen at any stage, press the  key so the  icon is flashing and then press .

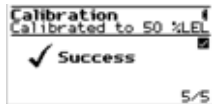

When the gas is applied the display will read the concentration relative to the actual applied gas.

Upon a successful calibration the corrected target-gas concentration will be shown on the 'Success' screen 5/5.

Note: the cross-calibration gas options (eg propane, pentane etc) will be listed as appropriate to the sensor module fitted.

*** Note: The gas concentration level for cross-calibration options is pre-set and cannot be adjusted.**

3.5.2.4. Inhibit

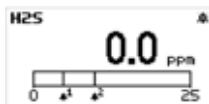
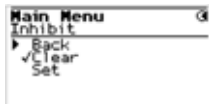

Note: when Inhibit mode is configured to 'Set':

- An 'alarms inhibited' icon will be shown on the screen.
- The analogue output of the transmitter will be fixed at the level configured in the 'Inhibit output' screen (see page 38)
- The alarm and fault* relays (if fitted) will not activate if alarms or faults are triggered.
- The display will continue to indicate the current gas level.
- Alarm LED and alarm icons will continue to activate/flash when the gas level is above alarm thresholds, but will automatically be set to non-latching (ie will de-activate automatically one the gas level returns to normal).



* There is an option to exclude the Fault relay from the Inhibit function: refer to Section 9: Functional Safety Manual.

Warning: The inhibit state will automatically time-out after 15 minutes to ensure the transmitter cannot be accidentally left in a potentially unsafe state for extended periods.

- ▶ Press the  key until the  is adjacent to the required option and press the  key.



3.5.2.5. Change Sensor

This function enables a user to change the **XgardIQ** sensor.

Note: *The XgardIQ transmitter can be configured with various restrictions when changing sensor modules. Refer to Section 3.10 for details.*

- ▶ With the  icon flashing, press .

To cancel the sensor change at any time, press

the  key so the  icon is flashing and then press . The Main menu will be displayed.

- ▶ Remove the sensor when prompted.

- ▶ Insert the required sensor when prompted.



- ▶ When the sensor is detected, its type will be displayed.

- ▶ It will then be initialised.

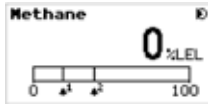
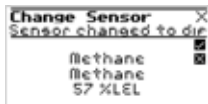
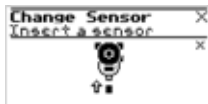
- ▶ And finally the sensor's status will be displayed.



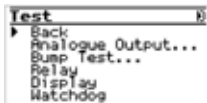

3.5.2.6. Test

- ▶ Press the  key until the  is adjacent to the required option and press the  key.



Analogue Output

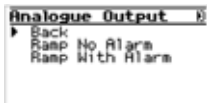

This function enables the user to set the ramp level with or without an alarm.

- ▶ Press the  key until the  is adjacent to the required option and press the  key.



Ramp No Alarm

This function will force the analogue output proportionally to the displayed gas level, but the Alarm relays and Alarm LED will not be activated. The analogue output will revert to the normal gas sensor level when the menu is exited.

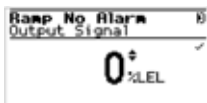

- ▶ Press the  and  keys to adjust the level to the required value then press .



Ramp With Alarm

This function will force the analogue output proportionally to the displayed gas level, the Alarm relays and Alarm LED will activate as their threshold are exceeded.

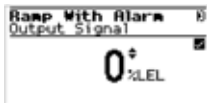

The analogue output will revert to the normal gas sensor level, and Alarm relays and LED's will deactivate when the menu is exited.

- ▶ Press the  and  keys to adjust the level to the required value then press .



Bump Test

A bump test can be performed at any time, or when a warning message is displayed. A failed bump test will activate a Bump test due warning on the **XgardIQ** transmitter.

- ▶ If necessary, use the  or  key to select which type of test is required and press .

Speedy Bump

This is a quick method of verifying that a sensor is working correctly whilst consuming the minimum quantity of test-gas.

Once activated, gas of an appropriate concentration to exceed the Alarm 1 threshold must be applied to the sensor using a calibration cap.

XgardIQ allows a time period (30 seconds maximum by default) for the sensor to respond beyond the Alarm 1 threshold.

The user is prompted to remove the gas and confirm when the sensor signal has reverted to normal levels.

The result of the test is then displayed (Passed or Failed).

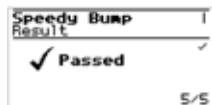
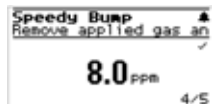
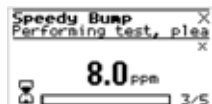
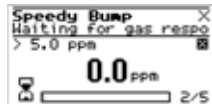
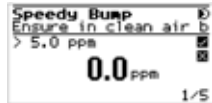
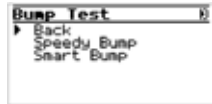

Note: the analogue output and Alarm relays (if fitted) are inhibited whilst the test is performed.

Smart Bump

The test verifies that a sensor responds correctly to a specified concentration of test gas.

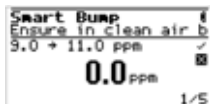

Once activated, gas of a concentration within the limits displayed must be applied to the sensor using a calibration cap.

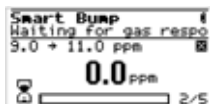

XgardIQ allows a time period (30 seconds maximum by default) for the sensor to respond. The menu will automatically step to the next screen once the sensor signal responds to the gas. If the sensor signal does not change within this period the test will be failed.

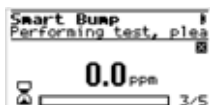

The test gas must remain on the sensor for the remainder of the test. Over the next time period (typically 30-90 seconds depending on sensor type) **XgardIQ** monitors the sensor reading and the test will be passed if the final reading falls within the range shown in step 1 of 5.

The user is prompted to remove the gas and confirm when the sensor signal has reverted to normal levels.

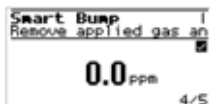

The result of the test is then displayed (Passed or Failed).

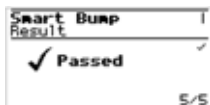

Note: the analogue output and Alarm relays (if fitted) are inhibit whilst the test is performed.

Note: for pellistor sensors an option may be provided to bump-test with an alternative gas (e.g pentane) which may be more easily available than the target gas.

Display

This function runs an animation on the screen so any missing pixels will be obvious.



Relay

This function enables the Alarm and Fault relays (if fitted) to be tested. Each relay can be switched individually between its current state and active state.

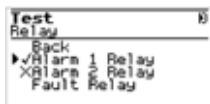





Move the cursor adjacent to the relay to be tested and then press the enter key to switch the relay.

Warning: external devices connected to the relay contacts (e.g. audible/visual alarms, valves, control system inputs etc.) will be activated using this function.

Watchdog

Warning: this function will reset the XgardIQ microprocessors and re-start the transmitter. This tests that the system re-starts correctly.

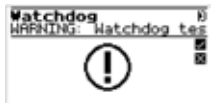

No configuration data or event log data will be lost, but the analogue output signal will be temporarily deactivated and the fault relay (if fitted) will change state. The control system and any other devices to which the transmitter is connected should be inhibited/isolated before using this function.

- ▶ To carry out the Watchdog function, press  with the  icon flashing.
- ▶ To cancel this function, press  so the  icon is flashing then press  to return to the Test menu.





3.5.2.7. Configure

This menu allows the user to configure the following functions:

- ▶ Press the  key until the  is adjacent to the required function and press the  key.





Analogue Output



This menu enables the analogue output to be adjusted and default options to be configured.





- ▶ Press the  key until the  is adjacent to the required option and press the  key.

Zero Trim

This function enables any inaccuracies in the analogue output signal at zero gas (ie 4mA) to be corrected. For example; if the sensor has been correctly zeroed and the display reads 0%LEL / 0ppm, but the analogue output is measured using an accurate meter at 3.9mA, the Zero trim function can be used to adjust the output signal by 0.1mA. The signal change is made in real-time as the adjustment is made. Once the signal has been measured at the correct 4mA level, the change can be made permanent by selecting the  icon.

- ▶ Press the  key to accept the displayed value or press the  key until the  icon flashes and then press the  key to edit the value.



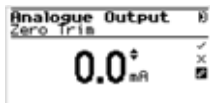
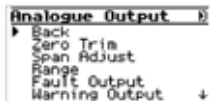
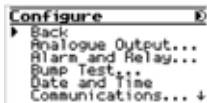

- ▶ Use the  and  keys to set the required value and then press  to return to the value screen.

- ▶ Press the  key to save this value and return to the Analogue Output menu or press the  key so the  icon flashes and then press the  key to abort the change and return to the Analogue Output menu.





Span Adjust





This function enables any inaccuracies in the analogue output signal at full-scale (ie 20mA) to be corrected. When the function is selected the analogue output will be set to 20mA. If the signal is measured using an accurate meter at (for example) 19.9mA or 20.1mA, the Span Adjust function can be used to adjust the output signal by 0.1mA. The signal change is made in real-time as the adjustment is made. Once the signal has been measured at the correct 20mA level, the change can be made permanent by selecting the ✓ icon.

- ▶ Press the  key to accept the displayed value or press the  key until the  icon flashes and then press the  key to edit the value.







- ▶ Use the  and  keys to set the required value and then press  to return to the value screen.





- ▶ Press the  key to save this value and return to the Analogue Output menu or press the  key so the  icon flashes and then press the  key to abort the change and return to the Analogue Output menu.

Range





The transmitter range (ie the gas level which equates to a full-scale 20mA output signal) can be set from 5% to 100% of the maximum sensor range. The maximum sensor range can be viewed at any time via the **Information/About/Sensor** screen (see page 23).

- ▶ Press the  key to accept the displayed value or press the  key until the  icon flashes and then press the  key to edit the value.







- ▶ Use the  and  keys to set the required value and then press  to return to the value screen.





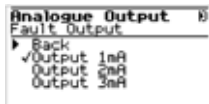

- ▶ Press the  key to save this value and return to the Analogue Output menu or press the  key so the  icon flashes and then press the  key to abort the change and return to the Analogue Output menu.

Fault Output

- ▶ Press the  key to accept the displayed value or press the  key until the  is adjacent to the required value and press the  key to return to the Analogue Output menu.





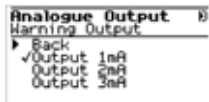

Warning Output

- ▶ Press the  key to accept the displayed value or press the  key until the  is adjacent to the required value and press the  key to return to the Analogue Output menu.





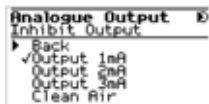

Inhibit Output

- ▶ Press the  key to accept the displayed option or press the  key until the  is adjacent to the required option and press the  key to return to the Analogue Output menu.







Power-on Inhibit

- ▶ Press the  key to accept the displayed option or press the  key until the  is adjacent to the required option and press the  key to return to the Analogue Output menu.



Mode

XgardIQ features a unique auto-sense function: it automatically detects whether the control system is configured as 4-20mA current Sink or Source and sets itself appropriately. If necessary **XgardIQ** can be manually set using this function.

- ▶ Press the  key to accept the displayed option or press the  key until the  is adjacent to the required option and press the  key to return to the Analogue Output menu.

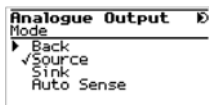

Alarm and Relay

This function enables a user to configure the Alarm 1 and 2 values and relay status.

- ▶ Use the or key to select which Alarm values to adjust and press .
- ▶ When all the required changes have been made, press the key to return to the Configure menu.

Alarm 1 and 2

- ▶ Use the or key to select which Alarm function to adjust and press .

On Threshold

- ▶ Press the key to accept the displayed value or press the key until the icon flashes and then press the key to edit the value.
- ▶ Use the and keys to set the required value and then press to return to the value screen.
- ▶ Press the key to save this value and return to the Alarm menu or press the key so the icon flashes and then press the key to abort the change and return to the Alarm menu.

Off Threshold



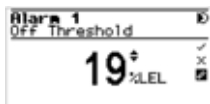
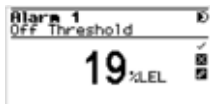
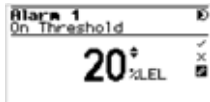
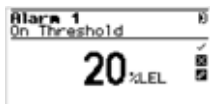
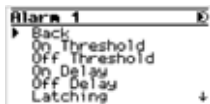

- ▶ Press the key to accept the displayed value or press the key until the icon flashes and then press the key to edit the value.
- ▶ Use the and keys to set the required value and then press to return to the value screen.
- ▶ Press the key to save this value and return to the Alarm menu or press the key so the icon flashes and then press the key to abort the change and return to the Alarm menu.







Operation

On Delay

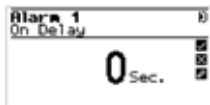



A time period of 300 seconds maximum can be set to delay relay activation after the gas concentration has exceeded the alarm threshold.

- ▶ Press the  key to accept the displayed value or press the  key until the  icon flashes and then press the  key to edit the value.

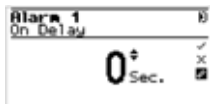





- ▶ Use the  and  keys to set the required value and then press  to return to the value screen.







- ▶ Press the  key to save this value and return to the Alarm menu or press the  key so the  icon flashes and then press the  key to abort the change and return to the Alarm menu.

Off Delay

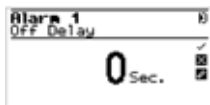



A time period of 300 seconds maximum can be set to keep the relay activated after the gas concentration has returned to a normal non-alarm level.

- ▶ Press the  key to accept the displayed value or press the  key until the  icon flashes and then press the  key to edit the value.

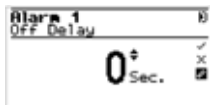





- ▶ Use the  and  keys to set the required value and then press  to return to the value screen.





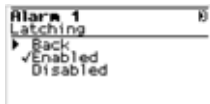

- ▶ Press the  key to save this value and return to the Alarm menu or press the  key so the  icon flashes and then press the  key to abort the change and return to the Alarm menu.

Latching





- ▶ Press the  key to accept the displayed option or press the  key until the  is adjacent to the required option and press the  key to return to the Alarm menu.

*Relay*

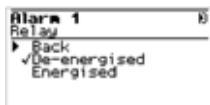
Note: this option will not be shown on XgardIQ transmitters with no relay module fitted.

- ▶ Press the  key to accept the displayed option or press the  key until the  is adjacent to the required option and press the  key to return to the Alarm menu.

*Direction*

- ▶ Press the  key to accept the displayed option or press the  key until the  is adjacent to the required option and press the  key to return to the Alarm menu.

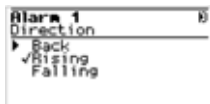



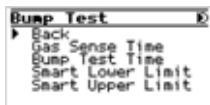

Bump Test

This function enables the user to configure the Bump test parameters.





Gas sense time



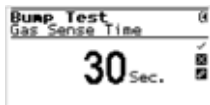

This parameter defines the time period in which the transmitter must detect a response from the sensor to the applied bump test gas.

- ▶ Press the  key to accept the displayed value or press the  key until the  icon flashes and then press the  key to edit the value.

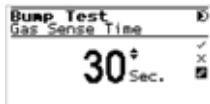





- ▶ Use the  and  keys to set the required value and then press  to return to the value screen.







- ▶ Press the  key to save this value and return to the Bump Test menu or press the  key so the  icon flashes and then press the  key to abort the change and return to the Bump Test menu.

Bump test time

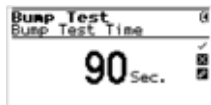



This parameter defines the time period over which a Smart Bump test is performed.

- ▶ Press the  key to accept the displayed value or press the  key until the  icon flashes and then press the  key to edit the value.

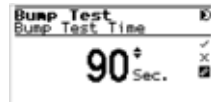





- ▶ Use the  and  keys to set the required value and then press  to return to the value screen.







- ▶ Press the  key to save this value and return to the Bump Test menu or press the  key so the  icon flashes and then press the  key to abort the change and return to the Bump Test menu.

Smart Lower Limit

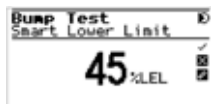



This parameter defines the minimum sensor reading for a successful Smart Bump test after the 'Bump Test Time' period is complete.

- ▶ Press the  key to accept the displayed value or press the  key until the  icon flashes and then press the  key to edit the value.

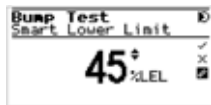

- ▶ Use the  and  keys to set the required value and then press  to return to the value screen.







- ▶ Press the  key to save this value and return to the Bump Test menu or press the  key so the  icon flashes and then press the  key to abort the change and return to the Bump Test menu.



Operation

Smart Upper Limit



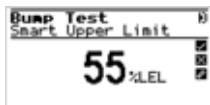

This parameter defines the maximum sensor reading for a successful Smart Bump test after the 'Bump Test Time' period is complete.

- ▶ Press the  key to accept the displayed value or press the  key until the  icon flashes and then press the  key to edit the value.

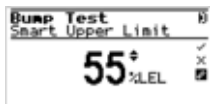





- ▶ Use the  and  keys to set the required value and then press  to return to the value screen.





- ▶ Press the  key to save this value and return to the Bump Test menu or press the  key so the  icon flashes and then press the  key to abort the change and return to the Bump Test menu.

Date and Time

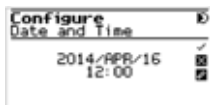
- ▶ Press the  key to accept the displayed date and time or press the  key until the  icon flashes and then press the  key to change the date and time.



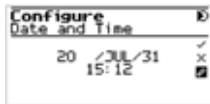

- ▶ If necessary, press the  and  keys to set the required field value and then press  to move to the next field.













- ▶ Repeat this procedure until all fields are correct and the corrected date and time are displayed.
- ▶ Press the  key to return to the Configure menu.









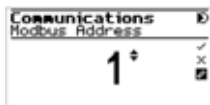

Communications

- ▶ Press the  key until the  is adjacent to the required interface address and press the  key.

*Modbus Address*

- ▶ Press the  key to accept the displayed value or press the  key until the  icon flashes and then press the  key to edit the value.
- ▶ Use the  and  keys to set the required value and then press  to return to the value screen.
- ▶ Press the  key to save this value and return to the Communications menu or press the  key so the  icon flashes and then press the  key to abort the change and return to the Communications menu.

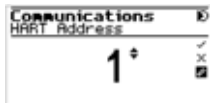

*HART Address*

- ▶ Press the  key to accept the displayed value or press the  key until the  icon flashes and then press the  key to edit the value.
- ▶ Use the  and  keys to set the required value and then press  to return to the value screen.
- ▶ Press the  key to save this value and return to the Communications menu or press the  key so the  icon flashes and then press the  key to abort the change and return to the Communications menu.



Note: Setting a HART address to anything other than 0 (the default) will put the instrument into a 'loop mode disabled' state to allow multi-dropping instruments via a HART network

Display

- ▶ Press the  key until the  is adjacent to the required interface address and press the  key.

Zero Suppression





Suppresses the displayed gas level and analogue output to a normal clean air level for small sensor signal deviations proportional to the Alarm 1 ON threshold. Suppression values:

None

Light 1% of configured Alarm 1 threshold





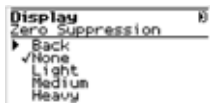

Medium 2% of configured Alarm 1 threshold

Heavy 5% of configured Alarm 1 threshold





- ▶ Press the  key to accept the displayed option or press the  key until the  is adjacent to the required option and press the  key to return to the Display menu.

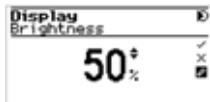
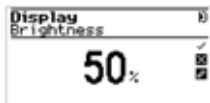

Brightness

- ▶ Press the  key to accept the displayed value or press the  key until the  icon flashes and then press the  key to edit the value.
- ▶ Use the  and  keys to set the required value and then press  to return to the value screen.



- ▶ Press the  key to save this value and return to the Display menu or press the  key so the  icon flashes and then press the  key to abort the change and return to the Display menu.

3.5.2.8. Information

Note: The procedures for this menu are identical to the Status menu (refer to Section 3.5.1 on page 22).

3.5.2.9. Event log

XgardIQ records alarm, fault and maintenance events for diagnostic purposes. The events are listed in time order with the most recent events at the top; older events can be browsed using the Up and Down arrow keys.

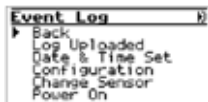

More details for each event can be viewed using the Up and Down keys to select the log of interest and pressing Select/Enter. A message screen will be shown detailing the time and date of the event and in some cases other information.



Many thousands of events can be stored and thus there is no risk of the memory becoming full. Events are stored in nonvolatile memory within the transmitter and thus will not be lost if power is removed. Events cannot be deleted.

3.6 Menu functions

3.6.1 Information menu structure

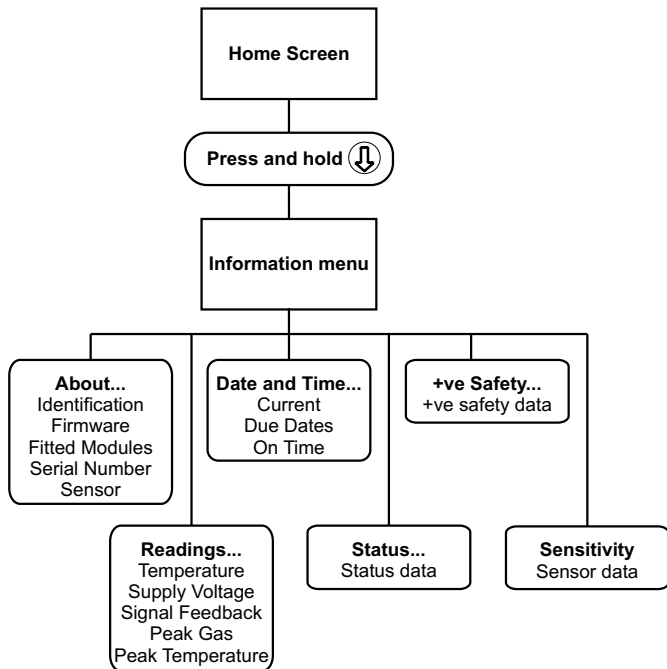

3.6.2 Main Menu structure

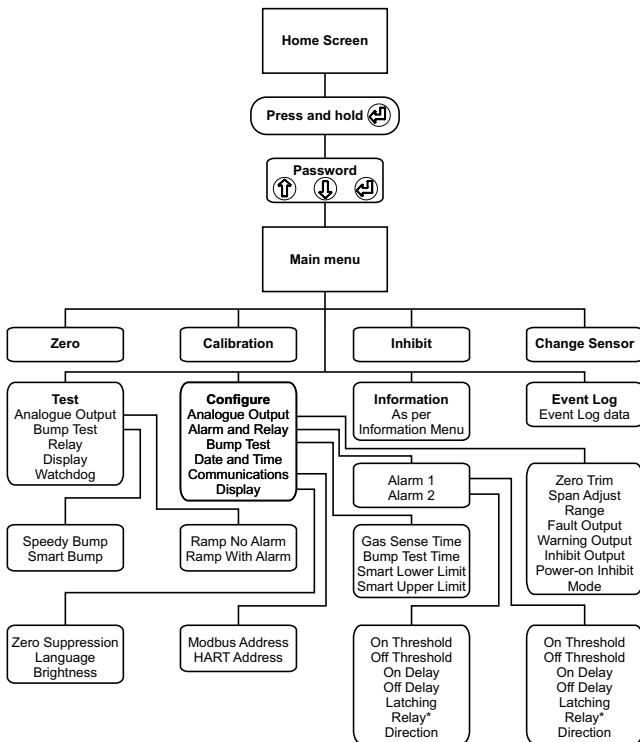

* The Relay option will not be shown on transmitters with no relay module fitted

3.7 Commissioning

Warning: Prior to carrying out any work ensure local regulations and site procedures are followed. Never attempt to unscrew the lid of the XgardIQ transmitter when flammable gas is present. Ensure that the associated control panel is inhibited so as to prevent false alarms.

Note: Where an XgardIQ transmitter has been installed a long time ahead of commissioning, a dummy sensor module should have been fitted to maintain ingress protection. The dummy sensor module should be removed and replaced with the sensor module (having first checked the quad-ring is in place and in good condition) with the appropriate gas type prior to commissioning.

3.7.1 Applying Power

1. Open the **XgardIQ** transmitter by unscrewing the lid in an anticlockwise direction (having loosened the retaining grub-screw first).
2. Check that all electrical connections have been made and are correct as per Diagram 14.
3. Unpack the sensor module and carefully insert it fully into the transmitter (or remote sensor housing).
4. Apply power to the detector and ensure a minimum supply voltage of 14V dc is present (see Supply Voltage display on page 23).
5. Allow the sensor to stabilise for the time period shown on the datasheet supplied with the sensor module. An hour-glass symbol will be shown whilst the sensor is stabilising.
6. **XgardIQ** should now operate as described in Section 3.4: Start up on page 20.
7. Verify the time and date are correct on the **XgardIQ** display and adjust if necessary.

3.7.2 Sensor Zero

Sensors should normally be zeroed before attempting calibration.

This function should be carried-out in 'clean air' (ie normal oxygen levels with no target gas presence) for most sensors. Sensors for gases that are normally present in the ambient environment (eg oxygen, carbon dioxide) can only be zeroed by applying 100% nitrogen to the sensor. The analogue output signal will be inhibited to the level configured in the 'Inhibit Output' menu (ie 1mA, 2mA, 3mA or 'Clean Air') whilst using the Zero function.

Refer to Section 3.5.2.1 on page 26 for instructions on using the Zero function.

3.7.3 Sensor Calibration

The calibration gas must only be applied to the sensor using the **XgardIQ** calibration cap (see Section 2.4.1 on page 13). For most sensors a flow-rate of 0.5 litres per minute is appropriate although this may vary for some sensor types. Refer to the datasheet supplied with the sensor module for specific instructions.

Calibration can be performed with a suitable gas concentration from 10% of the scaled sensor range to 100% of the maximum sensor range.

Example 1: the standard CO sensor has a maximum range of 0-1000ppm. Even if the sensor has been re-scaled to 0-250ppm or 0-500ppm (or any other value), calibration gas up to 1000ppm concentration can be used to calibrate the sensor without re-scaling the sensor.

The minimum calibration gas concentration that can be used is 10% of the scaled range.

Example 2: a CO sensor is set to its maximum range: 0-1000ppm. The minimum concentration calibration gas that could be used is 100ppm.

Example 3: a CO sensor has been re-scaled to 0-100ppm. The minimum concentration calibration gas that could be used is 10ppm.

The analogue output signal will be inhibited to the level configured in the 'Inhibit Output' menu (ie 1mA, 2mA, 3mA or 'Clean Air') whilst using the Calibration function.

Note: if a dust filter is to be fitted to the sensor module, it is essential that calibration is performed with the dust filter in-place.

Refer to Section 3.5.2.2 on page 27 for instructions on using the Calibration function.

3.7.4 Other Commissioning Checks

If the **XgardIQ** transmitter is connected to a control system, check:

- The type of cables and glands used are appropriate and correctly fitted/terminated.
- The earth and cable screen connections are correctly made.
- The labels shown in section 1.5 and 1.6 are present and clearly legible.
- The sensor has been installed in an appropriate location for the gas to be detected.
- Suitable accessories have been installed.
- The system input dedicated to the **XgardIQ** is not in fault and reads zero gas when the **XgardIQ** sensor reads zero (ie 4mA signal check).
- The system input dedicated to the **XgardIQ** reads full-scale gas when the **XgardIQ** output signal is set to 20mA.
- The system input dedicated to the **XgardIQ** goes into fault mode when a fault condition is present on the **XgardIQ** transmitter (eg by removing the sensor module).
- Any devices connected directly to the **XgardIQ** relay module (if fitted) operate correctly in an Alarm or Fault condition.
- The detector configuration is checked and signed-off by the user.

3.8 Routine maintenance

Site practices and conditions will dictate the frequency of routine maintenance, bump test and calibration procedures. **Crowcon** recommends that most sensors and transmitters are inspected and functionally tested every six months as a minimum.

Bump test and calibration: The specific recommended calibration period for sensors will be shown on the datasheet supplied with the sensor module.

XgardIQ incorporates a Bump test feature which enables sensor performance to be verified quickly either on a routine basis (eg every 3 months) or after a sensor has experienced an event that may have caused damage or sensitivity loss.

The **XgardIQ** transmitter will warn when routine calibration and bump test (if configured: see next section) is due.

The time spent by maintenance personnel in very hazardous areas can be minimized by removing the sensor module to a safe area for calibration (either via another **XgardIQ** transmitter or using a PC running Detectors Pro software). Once calibrated, the sensor module can be re-installed into the transmitter.

Sensor replacement: The typical life of each sensor type is shown on the datasheet supplied with the sensor module. Electrochemical and pellistor-type sensors should be replaced when they fail a calibration or bump test. See Section 3.10 on page 54 for instructions on changing sensor modules.

O-rings and seals: The O-ring fitted to the **XgardIQ** enclosure lid should be inspected periodically and replaced if damage is evident.

The quad-ring within the sensor module aperture is coated to ensure the sensor module slides into the transmitter easily. The quad-ring should be replaced periodically to ensure that water and dust ingress protection is maintained and so that sensor modules can be inserted/removed easily.

Dust filter accessory: This accessory is only recommended for use in extreme locations where sensor contamination is very likely. Where fitted, dust filter must be checked regularly (eg every 3 months) by performing a bump test.

Time and date: Verify the time and date are correct on the **XgardIQ** display.

3.9 Bump Test and Calibration Due Function

XgardIQ warns the user when a bump test or calibration is due. Calibration and Bump test intervals are factory set within the sensor module and can only be modified using **Crowcon's** Detectors Pro software (see Section 2.4.11 on page 14 for details).

Calibration due dates are typically set to 180 day intervals, with the actual date calculated in the transmitter from the 'Current' time and date. A 'Calibration reminder' message can also be set to appear at the required time before calibration is due (eg 30 days). 'Calibration reminder' will only be displayed and activate a +ve Safety warning; it will not affect the analogue output, fault LED or Fault relay.

Calibration Due and Bump Test Due functions can be set with the following options:

- **None:** no dates will be set and **XgardIQ** will not prompt for bump test or calibration
- **Reminder:** a message will be shown on the display and a +ve Safety event will be triggered. The screen message can be accepted but the +ve Safety indication will remain until the sensor has been bump tested or calibrated.
- **Warning:** The Fault LED will activate and the analogue output will be set according to the configuration in the Warning Output screen (see page 38)
- **Fault:** The Fault LED will activate and the analogue output will be set according to the configuration in the Fault Output screen (see page 38)

Crowcon default settings:

Calibration Due default setting: Warning

Bump Test Due default setting: None

Calibration Due and Bump Test Due messages/warnings can only be reset by performing a successful calibration or bump test.

A successful calibration resets both calibration and bump test due dates. A successful bump test updates the bump test due date only (not the calibration due date).

A failed calibration immediately sets the **XgardIQ** to calibration due state.

A failed bump test at any time (ie whether bump test is due or not) sets a bump due status immediately.

3.10 Changing sensor modules

XgardIQ sensor modules are Intrinsically Safe meaning they can be “hot-swapped” (removed/inserted whilst the transmitter is powered in a hazardous area). If required, sensor modules can be temporarily removed to a safe area for calibration (for example a laboratory) and re-inserted, or swapped for a new sensor module without needing a hot work permit. **XgardIQ** can be configured with a range of permissions to control the types of sensor module that can be inserted and also, where required, to restrict this facility to authorised personnel. The available configuration options can be adjusted using Detectors Pro software, and are as follows:

1. Accept same gas type only with acknowledgement: requires acknowledgement via a password protected menu.
2. Accept same gas type only without acknowledgement.
3. All changes allowed with acknowledgement: requires acknowledgement via a password protected menu.
4. Accept same gas type without acknowledgement, and changed with acknowledgement via a password protected menu.

XgardIQ transmitters are factory configured to accept any sensor module on first insertion, but once the configuration has been uploaded the transmitter will subsequently only accept sensor modules of the same gas type (as per option 2).

When inserting a sensor module, first ensure that the ‘quad-ring’ within the **XgardIQ** transmitter is present and is in good condition. Ensure the triangular moulding aligns with the corresponding cut-out in the transmitter enclosure, and press home firmly. Do-not apply pressure to the sensor itself as damage may occur.

A tool is available for removing the sensor module. Insert the tool and lever downwards to release the module from its connector



Diagram 19: Quad-ring location

Note: XgardIQ sensor modules are fully temperature compensated; it is therefore perfectly acceptable to calibrate in a laboratory and then re-install the module in an XgardIQ transmitter where the ambient temperatures are higher or lower.

3.11 Alarm Mode

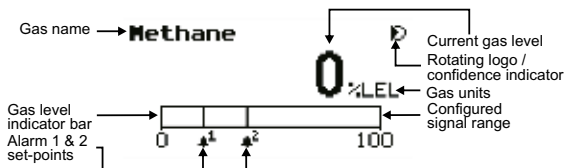

The current gas level will be indicated by the numeric display, and also by the gas level indicator bar.

For gases not normally present (eg methane) the gas level should be 0 and the gas level indicator bar should be black. Rising alarms will be set in this instance.

For gases expected always to be present (eg oxygen) the normal gas level (20.9% in this example) should be shown and the gas level indicator bar will be illuminated yellow proportional to the gas concentration. Most oxygen sensor applications will require falling alarms (to warn of oxygen depletion) and thus the gas level indicator bar will be illuminated yellow beyond the alarm set-points normally.

As the gas level approaches an alarm set-point the alarm bar will begin to flash. When an alarm set-point is passed:

- The colour of the alarm bar will be inverted
- The alarm icon will flash
- The display brightness will be set to maximum
- The red Alarm LED will activate for level 1 alarms, and flash once per second for level 2 alarms
- If fitted; the appropriate alarm relay will activate

Note: alarms may be set as latching or non-latching. The red Alarm LED and alarm relay (if fitted) will automatically de-activate on non-latching alarms when the gas level returns to normal. The red Alarm LED and alarm relay (if fitted) will remain active on latched alarms until the Select/Enter/Reset key is pressed. Alarm relays may have on-delays and/or off-delays applied. For details of relay configuration see the Alarm and Relay section on page 39.

3.11.1 Alarm settings

To comply with the requirements of EN50104: 2010: where Alarm 1 and Alarm 2 are in the same direction (eg both rising), Alarm level 1 can be set as latching or non-latching. The higher level alarm (Alarm 2) must be latching only. Where one rising, one falling alarm are set, both alarms must be latching.

3.12 Pellistor saver mode

In order to protect pellistor-type sensors from damage when exposed to high gas concentrations, **XgardIQ** incorporates a 'Pellistor saver' mode. If the signal from the sensor exceeds 90%LEL the system removes power from the sensor.

The analogue output signal will continue to indicate an over-range gas concentration (ie 23.5mA max) and the display will show ">100%LEL" along with an hour-glass symbol. A +ve Safety warning state will also be activated.

This state will latch for 200 seconds (to comply with European performance standard requirements) after which it can manually be reset by pressing the Enter key. Power is restored to the sensor and the pre-set stabilization period is re-applied to allow the sensor to settle. It is advisable to check that no flammable gas remains in the area of the detector before re-setting.

If the gas concentration has dropped below 90%LEL the sensor will revert to normal operation, if the concentration is still above 90%LEL the transmitter will re-activate Pellistor saver mode.

It is advisable to bump-test the sensor after the Pellistor saver mode has been reset to ensure that sensitivity has not been affected.

3.13 Operating parameters

After changing any configurations using an external device (eg a PC or HART communicator) the user must check that the settings applied are correct by either:

- 1: verifying the configuration settings on the display
- 2: re-checking the configuration after the PC or HART communicator has been disconnected and re-connected.

4. Specification

Dimensions	XgardIQ transmitter Remote sensor housing	H278 x W140 x D89mm (10.9 x 5.5 x 3.5 inches) H105 x W105 x D70mm (4.1 x 4.1 x 2.7 inches)
Weight		4.1kg (9lbs)
Enclosure material		316 Stainless Steel
Ingress Protection		IP66
Connection		Three M20 or 1/2" NPT cable gland entries. Certified, removable plugs are fitted to left-hand and lower right-hand entries
Power		14-30V DC. 4W max
Display	Main display	OLED 128 x 64 pixels, yellow text on black background
	Indicators	Amber, Red and Green LED's for detector status Blue +ve Safety LED
Electrical output		4-20mA current sink or source (Auto-Sense or manual selection) Warning and fault signals are configurable NAMUR NE 43 compliant
		RS-485 Modbus RTU
		HART 7 over 4-20mA signal and via local I.S. test points (optional)
		Foundation Fieldbus (option pending, contact Crowcon)
	Relays (optional)	Alarm 1, Alarm 2, Fault SPCO contacts rated 5A, 230Vac non-inductive (Fault relay: SPST contact)
	Relay configuration options	Energised or de-energised Latching or non-latching Rising or falling Configurable On and Off delays for alarm relays
Event logging		Records alarm, fault and maintenance events. Events can be viewed on-screen and downloaded to a PC.
Operating temperature		Transmitter only: -40°C to +75°C (-40°F to 167°F) Note: sensor operating temperatures vary widely. Refer to the sensor module datasheet or contact Crowcon for specific sensor data.

Specification

Humidity		Transmitter only: 0 to 95% RH non-condensing Note: sensor humidity operating ranges may vary. Refer to the sensor module datasheet or contact Crowcon for specific sensor data.
Repeatability		+/- 2% FSD
Zero drift		+/- 2% FSD per year maximum
Response time		Sensor dependant: refer to the sensor module datasheet or contact Crowcon for specific sensor data.
Performance	Tested in accordance with:	EN60079-29-1 (flammable gas sensors)* EN50104 (oxygen sensors)* EN45544 (toxic gas sensors)*
Functional safety		IEC61508, EN50402 SIL 2* EN50271
Approvals		 ATEX and IECEx Ex II 2 G Ex db ia IIC T4 Gb (-40 to +75°C) Certificate numbers: Baseefa14ATEX0012X IECEx BAS 14.0001X Standards: EN60079-0:2012 + A11:2013, EN60079-1:2014, EN60079-11:2012. IEC60079-0:2011, IEC60079-1:2014-06, IEC60079-11:2011.
EMC compliance		EN50270:2015 FCC CFR47 Part 15B ICES-003

*Features outstanding at the time of issue, contact **Crowcon** for details.

5.1 XgardIQ Spares

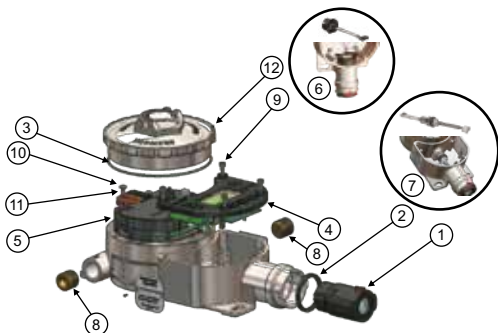

Diagram 20: *XgardIQ* exploded view

- ① Sensor module (refer to the original sensor module or datasheet for product code).
- ② Quad-ring
- ③ Enclosure lid o-ring
- ④ Display module assembly
- ⑤ Main PCB assembly
- ⑥ D-connector, moulding and lead assembly
- ⑦ Terminal PCB to display PCB cable assembly (includes Exd cable bush)
- ⑧ Stopping plug (M20, or ½" NPT)
- ⑨ M4 x 12 cap head screw
- ⑩ M4 x 8 pozidrive pan head screw
- ⑪ M4 spring washer
- ⑫ M3 grub screw

Contact **Crowcon** for spares part numbers.

6. Fault finding

6.1 General

Abnormal operating conditions are split into the following categories: +ve Safety™, Information, Warning, Fault. Each is described in this section.

All of the following details assume default settings are configured on the **XgardIQ**. "Clean air" means an analogue output signal of 4mA for all gases except oxygen where the signal will be 17.4mA.

6.2 +ve Safety™

The blue +ve Safety LED will flash if any of the following conditions exist:

- Any Fault condition
- Any Warning condition
- Any Information condition (with a few exceptions: see table)

Full Description	Display Code	Display	Explanation	Remedy/ action
Pellistor saver. See notes 3&4 on page 71.	0	>100%LEL	Pellistor sensor is in over-range state and supply voltage has been cut.	This state latches for 200 seconds, after which (when the hour-glass icon has disappeared) it can be reset by pressing the Select/ Enter/Reset key to restore sensor power supply and re-active gas measurement. Bump test the sensor to check it has not been damaged.
Loop mode disabled.	10	Gas level	Analogue output has been disabled via HART where the detector is intended to be used as part of a HART addressable network.	None.

Full Description	Display Code	Display	Explanation	Remedy/action
Detector inhibited.	11	Alarm inhibited icon	Analogue output and relays (if fitted) are inhibited and therefore will not provide warning of gas events.	Manually clear the inhibit state. An inhibit state will time-out automatically 15 minutes after the last function was used.

6.3 Information

Information condition indications:

- Display message
- +ve Safety LED flashes at 1Hz (with a few exceptions: see table).

Full Description	Display Code	Pop-up Display Message	Explanation	Remedy/action
Sensor software fault. See note 4 on page 71.	2	Sensor firmware fault	Sensor module firmware self-check failure. Software will automatically re-start.	Replace sensor module. If fault persists contact Crowcon .
Main unit software fault. See note 4 on page 71.	3	Main firmware fault	Main PCB firmware self-check, assert or watchdog failure.	Replace main PCB. If fault persists contact Crowcon .
Watchdog test failure	9	Watchdog test failure	Software watchdog test function has failed.	Power-cycle detector. If detector fails to start-up or the fault re-occurs, replace main PCB.
Ambient temperature warning. See note 1 on page 71.	44	Display temperature fault	Ambient temperature measured within the display module out of specification.	Test detector functions when ambient conditions are within normal parameters.

Fault finding

Full Description	Display Code	Pop-up Display Message	Explanation	Remedy/action
Sensor over-range. See notes 3&4 on page 71.	25	Sensor over range	Gas level above sensor maximum capability, potentially due to excessive gas in area.	Check for gas presence, condition will clear when sensor signal returns to normal levels.
Event log data error. See note 1 on page 71.	37	Log data error	Error detected in event log during initialisation – log data lost.	No solution, log will automatically re-start and continue.
Event log data record error. See note 1 on page 71.	38	Log data lost	One or more events failed to be logged (log too busy or verification of data written failed).	Some events may be lost, logging function will continue.
Display module missing or corrupted. See note 1&2 on page 71.	40	Display missing	No XgardIQ Display module detected or Display module firmware is an old revision.	Replace display module.
Display module hardware fault. See note 1&2 on page 71.	41	Display hardware failure	Hardware failure – Vcc, EEPROM or supply voltage	Replace display module.
Display firmware fault. See note 1&2 on page 71.	42	Display firmware fault	Display module firmware fault.	Replace display module. If fault persists contact Crowcon.
Error in 2nd display language. See note 1 on page 71.	43	Language data error	Error detected in second display language characterisation data.	Download language file using Detectors Pro software.

Full Description	Display Code	Pop-up Display Message	Explanation	Remedy/action
Biased sensor module battery fail. See note 1 on page 71.	47	Biased battery failure	Battery fitted to biased sensor module (NO, HCl, ETO) has failed (increased stabilisation time required for sensor after the transmitter has lost power).	Replace battery or complete sensor module.
Calibration due pre-warning. See note 4 on page 71.	55	Calibration due soon	Calibration pre-warning of pending calibration due date.	Re-calibrate the sensor. The transmitter will automatically reset the next due date.
Bump test due. See note 4 on page 71.	56	Bump test over-due	Sensor bump test due.	Bump-test the sensor. The transmitter will automatically reset the next due date.
Internal communications error.	59	Internal communications data error	Data set by Display module rejected by main PCB.	Power-cycle detector, if the fault re-occurs connect Detectors Pro software to diagnose. Return to Crowcon .
+ve Safety lost	60	+ve safety data lost	Latched +ve Safety data lost	Check event log for details of +ve safety events.
Modbus data download error. See note 4 on page 71.	61	Modbus download error	Modbus configuration download started but not completed.	Check and verify transmitter configuration (eg Modbus address) and update using Detectors Pro software as required.

Full Description	Display Code	Pop-up Display Message	Explanation	Remedy/action
Sensor module initialization error	36	Sensor system fault	Unexpected sensor module re-start.	Ensure sensor module is correctly fitted. Check for excessive local EMC sources.
Display module initialization error	45	Display system fault	Unexpected display module re-start	Ensure display module is correctly fitted. Check for excessive local EMC sources

6.4 Warnings

Warning condition indications:

- Display message
- Analogue output set to 2mA (configurable to 1,2 or 3mA)
- Fault LED activates
- +ve Safety LED flashes once per second

Note: Analogue output operation whilst in Warning state: Gas Alarms always take precedence above Warning states. If the gas level exceeds an alarm threshold whilst the transmitter in Warning state the Alarm LED will activate, the Fault LED will de-activate and the analogue output signal will be set proportional to the current gas level.

When the sensor signal subsequently returns to a non-alarm level (and latched alarms have been manually reset) the Warning state conditions will resume.

Full Description	Display Code	Pop-up Display Message	Explanation	Remedy/action
Sensor requires calibration	15	Gas calibration required	Calibration required (after a successful zero)	Re-calibrate sensor.

Full Description	Display Code	Pop-up Display Message	Explanation	Remedy/action
Sensor has been exposed to extreme temperatures. See note 4 on page 71.	21	Sensor temperature fault	Sensor temperature outside allowed limits (too cold or too hot)	Bump test sensor.
Ambient temperature warning.	34	Ambient temperature fault	Ambient temperature measured within the XgardIQ transmitter out of specification (too cold or too hot)	Test detector functions when ambient conditions are within normal parameters.
IR sensor obscuration warning. See note 4 on page 71.	51	Optics warning	Optical obscuration warning (IR sensors only)	Check sensor optics, clean if necessary.
Real time clock failure	53	Time/date lost	Time/date lost or failure of Real Time Clock.	Reset time and date, leave instrument powered for 2 hours to re-charge super-cap. Contact Crowcon if fault persists.
Bump test due	56	Bump test over-due	Bump test due. Set to Warning by configuration	Bump-test the sensor. The transmitter will automatically reset the next due date.

6.5 Faults

Fault condition indications:

- Display message
- Analogue output set to 1mA (configurable to 1,2 or 3mA)
- Fault LED flashes at 1Hz
- +ve Safety LED flashes at 1Hz
- Fault relay activates (if fitted)
- Setting the transmitter into Inhibit mode.

Note: Faults are latched for 30 seconds and will automatically be cleared when the cause is removed.

Note: Fault states take priority over alarms: the analogue output signal will be set at Fault level (normally 1mA) even though alarms may have been registered.

Note: Analogue output feedback faults: If an error is detected with the analogue output signal (either due to a wiring fault or incorrect manual setting of the Sink/ Source function) the transmitter will go into fault mode and analogue 4-20mA signal will latch at the minimum signal level (~1mA). The analogue output signal can be re-activated by:

- Manually selecting the correct Mode: Sink or Source (see page 38)
- Using the Ramp function (see page 32)
- Reset the processor using the Watchdog function (see page 35)
- Power-cycling the detector

Full Description	Display Code	Pop-up Display Message	Explanation	Remedy/action (options shown in priority order for some faults)
Sensor hardware fault	0	Sensor hardware fault	Sensor module hardware failure – ROM, RAM, Vcc, CPU EEPROM or other CPU fault, supply voltage fault or hardware/ firmware mismatch.	Replace sensor module
Main hardware fault	1	Main hardware fault	Hardware failure – Vcc, RTC failure, logging flash or CPU EEPROM fault	Replace main PCB

Full Description	Display Code	Pop-up Display Message	Explanation	Remedy/action (options shown in priority order for some faults)
Undefined sensor fault	4	Undefined fault in sensor	Undefined fault in sensor module (i.e. undefined status bit set).	Replace sensor module
Analogue output measurement failure	7	Analogue output feedback fault	Analogue output feedback failure	<ol style="list-style-type: none"> 1. Check and correct wiring or sink/source configuration error and either power-cycle the transmitter, or use the Watchdog test function. 2. Re-calibrate analogue output. 3. Replace main PCB
Sensor fault	8	Under/over range, detector fault	Sensor signal under-range or over-range, detector failure or other sensor failure.	<ol style="list-style-type: none"> 1. Check for gas. 2. Remove and ref-fit sensor module. 3. Replace sensor module.
Outdated sensor hardware or config	11	Sensor version fault	Sensor module or configuration version too old	Replace sensor module
Sensor module missing	12	Sensor Missing	Sensor module missing (or not communicating with main PCB)	<ol style="list-style-type: none"> 1. Re-fit/replace sensor module. 2. Replace main PCB

Fault finding

Full Description	Display Code	Pop-up Display Message	Explanation	Remedy/action (options shown in priority order for some faults)
Calibration error	17	Gas calibration data error	Error detected in calibration data.	Re-zero and re-calibrate the sensor.
Sensor characterisation error	18	Gas characterisation data error	Error detected in sensor characterisation data	1. Re-configure sensor module via DetectorsPro. 2. Replace sensor module.
Sensor signal too low. See note 4 on page 71.	22	Measurement zero error	Measured gas level too low.	Re-zero and re-calibrate sensor.
Span error	23	Measurement span error	Factory set by Crowcon for certain sensors only. Measurement span error: sensor is reading above configured limit.	Check for gas presence, condition will clear when sensor signal returns to normal levels.
IR sensor optical obscuration. See note 4.	24	Optics obscured	Optics obscured (IR sensors only)	Check sensor optics, clean if necessary.
Analogue output calibration error	28	mA output calibration data error	Error detected in analogue output calibration data	Re-calibrate analogue output with Detectors Pro software.
Production process incomplete.	6	Production failure	Analogue output calibration or gas calibration not performed/ completed. Production configuration not performed	Return to Crowcon for re-programming.

Full Description	Display Code	Pop-up Display Message	Explanation	Remedy/action (options shown in priority order for some faults)
Error in characterisation data.	29	Main characterisation data error	Transmitter configuration lost.	Re-configure using Detectors Pro software.
Supply voltage too low. See note 5 on page 71.	32	Supply voltage low	Supply voltage below minimum level.	Check and adjust transmitter power supply.
Supply voltage too high. See note 5 on page 71.	33	Supply voltage high	Supply voltage above maximum level.	Check and adjust transmitter power supply.
Sensor module swapped for different gas type.	48	Sensor changed; different gas	Sensor module has been swapped for another measuring a different target gas. This message will only be displayed if the transmitter is configured as "All changes allowed with acknowledgement" or "Accept same gas type without acknowledgement, and changed with acknowledgement".	Replace sensor module with original gas type, or acknowledge gas type change if appropriate for the application.
Sensor module swapped for another of the same gas type.	49	Sensor changed; same gas	Sensor module has been swapped for another measuring the same target gas. This message will only be displayed if the transmitter is configured as "Accept same gas type only with acknowledgement".	Acknowledge to accept replacement sensor module.

Fault finding

Full Description	Display Code	Pop-up Display Message	Explanation	Remedy/action (options shown in priority order for some faults)
Sensor module swap rejected.	50	Sensor changed; change rejected	Sensor module has been swapped for another measuring a different target gas. This message will only be displayed if the transmitter is configured as "Accept same gas type only with acknowledgement" or "Accept same gas type only without acknowledgement" .	Re-fit original sensor module or a replacement module for the same gas type. If a change to a different gas type is required and appropriate, re-configure the "Action on sensor change" options using Detectors Pro software.
Calibration due	54	Calibration over-due	Calibration due: sensor requires immediate calibration	Re-calibrate the sensor. The transmitter will automatically reset the next due date.
Bump test due	56	Bump test over-due	Bump test due.	Bump-test the sensor. The transmitter will automatically reset the next due date.
Main system	35	Transmitter system fault.	Internal systems failure.	Power-cycle the transmitter (or use Watchdog function). If problem persists replace sensor, then display, then main PCB's.

Notes:

- 1: +ve Safety LED does not flash for this state.
- 2: Display message may not be shown.
- 3: Alarm LED will flash.
- 4: Latched +ve Safety event: the condition may have cleared but the +ve Safety LED will remain flashing until the appropriate action has been taken.
- 5: Green Power LED flashes.

6.6 Status LED

An orange status LED can be viewed by removing the enclosure lid (having observed safety precautions as described in Section 1.2). This LED can be used to identify the basic transmitter operating state if (for example) the display module has failed.

LED Pattern	Detector Status	Action
Regular on/off each second	Healthy	
Fast flash (twice per second)	In start-up mode	Wait 30 seconds (may be longer for some sensor types)
Long double flash each second	Information mode	Check 'Status' and/or +ve Safety screen for more information on the cause.
Single flash each second	Warning mode	Check 'Status' screen for more information on the cause.
Fast double flash each second	Fault mode	Check 'Status' screen for more information on the cause.

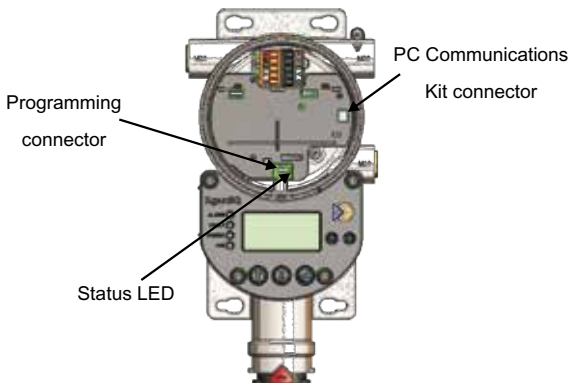

Diagram 21: Status LED, programming connector and PC Communications kit connector

6.7 Analogue Output

XgardIQ actively monitors the analogue output signal; if a problem is detected (eg a wiring fault or a sink/source configuration error at the transmitter or control panel) the transmitter will latch into Fault state and the analogue output will be set at 1mA. A message stating "Analogue output feedback fault" will be displayed.

To reset this state correct the wiring/configuration error and either power-cycle the transmitter, or utilise the Watchdog test function (see page 35).

6.8 Analogue Output Simulation

To test a transmitter without it being connected to a control panel, connect a 24Vdc supply to the +V and 0V terminals (terminals 1 and 2) and connect a wire-link between the 0V and Sig terminals (terminals 2 and 3). This will enable the transmitter to operate in Healthy state. If an analogue output feedback fault is displayed check the Mode is set as 'Auto Sense' (see page 38).

6.9 Data retention

All configuration data and logged events are stored in nonvolatile memory, and thus will be retained indefinitely whilst the transmitter power is isolated, or during storage and transit.

A 'super-cap' is fitted to retain the time and date during temporary power losses (up to 24 hours) and during a Watchdog test, however the time and date may be lost and revert to 01/01/2000 if power is lost and the super-cap becomes discharged. In this instance, after re-powering the detector, new events will be stored with a date starting from 01/01/2000 until the time and date has been reset by the operator.

6.9.1 Default settings

Relay Defaults:

Fault relay: Normally energised

Alarm relays: Normally de-energised, Rising alarm (toxic and flammable gas sensors; one rising, one falling alarm for oxygen sensors), Latching, On delay and Off delay set to 0 seconds.

Analogue Output Defaults:

Mode: sink-source auto-detect at power-on.

Fault level: 1mA

Warning level: 2mA

Inhibit level: clean air (4mA for toxic, flammable gas sensors, 17.4mA for oxygen sensors)

Power-on inhibit: 2mA (applies for the stabilisation period of the sensor)

7. RS485 Modbus configuration

7.1 General

XgardIQ provides RS-485 Modbus RTU communications as standard. This function can be used in conjunction with the 4-20mA analogue signal to transmit data to a central control system, or used for multi-dropping detectors on an addressable network.

Up to 32 **XgardIQ** transmitters can be linked in a Star or Bus configuration depending on the sensor type fitted and power requirements for switching ancillary devices such as alarms from the same DC supply. Guidance is given in Section 7.2.

Two five-way removable field cable connectors are provided enabling connections to be 'looped' to an adjacent detector. Connector/terminal functions are shown in Diagram 22. The connectors and sockets are colour coded to identify their correct location.

As standard **XgardIQ** is shipped with the top-right side cable entry open for field cable connection. The following instructions therefore assume that primary connections are made to the corresponding right-hand black field cable connector.

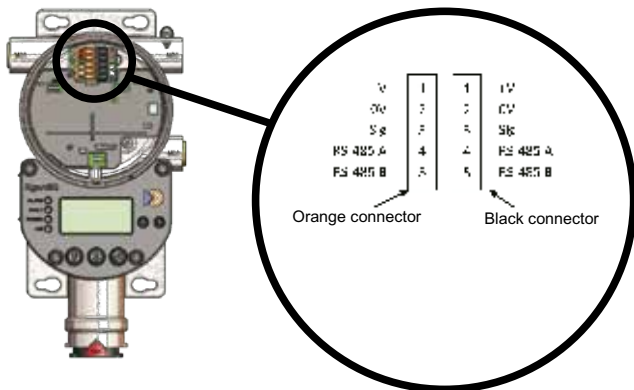

Diagram 22: Field Cable Connector functions

Note: The transmitter will not function if the field cable connectors are swapped (e.g. a pre-wired orange connector is plugged into the black socket). No damage will occur to the transmitter in this instance.

The signals on the RS485 terminals conform to the EIA/TIA-485 standard, which means that the common mode range is -7V to +12V with respect to the 0V terminal.

Note that not all RS485 manufacturers agree on the polarity of the A and B signals. If the wiring does not work one way, users should switch the RS485 A&B wires. There is no risk in making the wrong connection.

The communication settings are 38400 bps, two stop bits and no parity.

When compiling an interface for a control system, it is important to consider the amount of time it takes for the system to collect information from each detector in turn. The fastest speed at which multiple detectors can be polled is 14 detectors per second; practical conditions may reduce this to 7 per second. Users must ensure that the arrangement allows alarm signals to be registered within acceptable time limits.

It is also important to ensure that the system can supply enough power to keep all the detectors working. To calculate the amount of power required in a linear bus connection, see Section 7.3, Cabling requirements, on page 77.

Note: XgardIQ will operate as a Modbus 'Slave' and must be connected to a host 'Master' control system for which an interface will need to be compiled. A 'Modbus Map' document is available containing all of the connection and address information necessary to compile a suitable Modbus software interface.

A detailed 'XgardIQ Modbus Instructions' document is available containing all of the connection and address information necessary to compile a suitable Modbus software interface. This document can be downloaded from:

www.crowcon.com/uk/products/fixed-detectors/xgardiq.html

Note: Event-log data cannot be uploaded via Modbus; only via Crowcon's Detectors Pro software.

7.2 Wiring topology

Option 1: using Modbus for information only. The safety function is provided by the analogue 4-20mA signal to a PLC/DCS or conventional gas detector control system. Two additional cable cores are used to transfer Modbus data over the RS-485 platform to a PC or SCADA system. The PC/SCADA system can then display detector status information continuously or periodically as required. The Modbus connection can be 'multi-dropped' to several detectors if required.

The Modbus data cables from multiple transmitters can be connected in Star or Bus topologies if required, however the 4-20mA signals must be run individually back to the control system.

Option 2: using Modbus as the primary signal. In this use-case the control system will control the safety functions (alarms, shut-downs) as well as displaying status information from a single detector or an addressable network of detectors.

7.2.1 Star connection

In a star-connected topology all detectors are wired to a central point, which is usually the control panel. The RS485 A and B signals are connected together at the star point. The bus should then be terminated at the star point with a single 110 ohm termination resistor. The length of each arm of the star may not exceed 750 metres.

7.2.2 Bus connection

In a bus-connected topology all transmitters are wired to a linear arrangement, usually with the control panel at one end. A classic situation is a tunnel installation, with XgardIQ transmitters installed at regular intervals.

Two 110 ohm-terminating resistors should be fitted: one at each physical end of the bus.

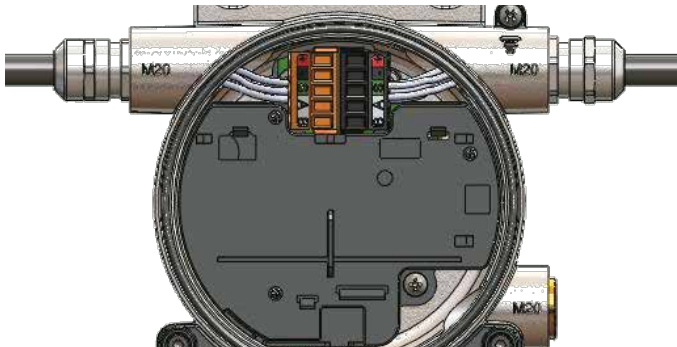

Diagram 23: Bus connection wiring topology

7.3 Cabling requirements

7.3.1 Calculating the minimum level of power required

The more **XgardIQ** detectors connected to the linear bus, the greater the power required to run the system. To calculate the power required for a particular setup, it is necessary to know the cable resistance between each pair of **XgardIQ** detectors. A current of a maximum 0.2A must be allowed for each 'hop' between each transmitter (this assumes the highest power configuration for each transmitter: pellistor sensor, relays energized). The voltage to be applied can be calculated by estimating the voltage drop across each 'hop' – at the end at least 14V must remain to ensure that the last **XgardIQ** functions correctly.

Follow the steps outlined below and the sample calculation shown in the next section to calculate for specific applications.

1. The voltage must not fall below 14V, so start the calculation by setting the voltage at the last **XgardIQ** in the line at that value.
2. Each **XgardIQ** may draw up to 0.2 A. Calculate the cable voltage loss of the first 'hop' between detectors by taking the 'aggregate current' to be 0.2A, and multiply this by the cable resistance of the 'hop' between the last and the last but one **XgardIQ**.
3. Add this voltage drop to the initial 14V to get the lowest acceptable voltage at the last but one **XgardIQ**. Add 0.2 A to the value for the 'aggregate current' to get to 0.4 A, the minimum current running through the last but one 'hop' of the bus. Multiply this by the cable resistance for the last but one 'hop' to get the next voltage drop.
4. Repeat this process for each **XgardIQ**, accumulating the voltage losses that will occur between each **XgardIQ**.
5. The maximum detector voltage of 30V must not be exceeded.

RS485 Modbus configuration

7.3.2 Sample calculation

As an example, here are the results of the calculation for six **XgardIQ** detectors spaced equally 50 metres apart on cable with cross-sectional area of 1.5mm². Each **XgardIQ** is assumed to have a pellistor sensor and a relay module (ie the highest power version of the product).

	Voltage at Detector	Cable Current	Cable Voltage Drop
XgardIQ 1	14.00	0.2	0.03
XgardIQ 2	14.03	0.4	0.06
XgardIQ 3	14.09	0.6	0.09
XgardIQ 4	14.18	0.8	0.12
XgardIQ 5	14.30	1	0.15
XgardIQ 6	14.44	1.2	0.18
XgardIQ 7	14.62	1.4	0.21
XgardIQ 8	14.83	1.6	0.24
XgardIQ 9	15.07	1.8	0.27
XgardIQ 10	15.33	2	0.30
XgardIQ 11	15.63	2.2	0.33
XgardIQ 12	15.95	2.4	0.36
XgardIQ 13	16.31	2.6	0.38
XgardIQ 14	16.69	2.8	0.41
XgardIQ 15	17.11	3	0.44
XgardIQ 16	17.55	3.2	0.47

Minimum Panel Voltage required	18.03 V
Panel Current	3.2 A

8. HART Communications

8.1 Overview

HART communications can be enabled as an option at the time of order only. HART enabled transmitters can be identified via the display menu.

The HART (Highway Addressable Remote Transducer) Protocol is the global standard for sending and receiving digital information across analogue wires between smart devices and control or monitoring systems.

More specifically, HART is a bi-directional communication protocol that provides data access between intelligent field instruments (gas detectors, level gauges, pressure transmitters etc) and host systems. A host can be any software application from technician's hand-held device or laptop to a plant's process control, asset management, safety or other system using any control platform.

HART communications is available as an option on **XgardIQ** in following formats:

8.2 Local hand-held HART communicator connection

Industry-standard HART communicators are used on industrial sites for maintaining and calibrating a host of instruments. The key benefit of HART is site maintenance staff can use a common communicator to maintain all of their safety and process instruments. The user simply needs to upload and install the DD (Device Descriptor) file to their communicator to access the **XgardIQ** functions.

Hand-held HART communicator connection is made using clips to connect to the I.S. pins located on the front of the display module. The pins are not polarity-specific: the clips can be connected either way round.

I.S. (Intrinsically Safe) pins
for hand-held HART
communicator connection.



Diagram 24: IS connection location

8.3 HART over the 4-20mA signal line

The HART protocol is super-imposed over the **XgardIQ** transmitter 4-20mA signal to provide the additional data listed. In this mode of operation the safety function is performed by the 4-20mA signal (connected to a conventional controller or PLC/DCS). A HART device can then be connected in parallel with the signal connections to read the **XgardIQ** transmitter status information. HART devices include hand-held communicators, a PLC with HART connectivity or a PC-based Asset Management System (AMS) communicating via a HART modem.

8.4 XgardIQ transmitters multi-dropped on a HART addressable network

It is possible for multiple **XgardIQ** transmitters to be connected to a control system solely using HART addressable communications. In this case each **XgardIQ** must be set with a unique HART address and the safety function (eg signal to DCS system, activation of alarms or valves) may be provided using the **XgardIQ** relay module.

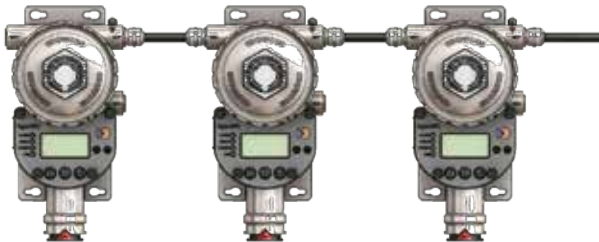

Diagram 25: Multiple *XgardIQ* connection

Note: To connect multiple *XgardIQ* transmitters in HART addressable mode each transmitter must be set to “Loop mode disabled” mode using *Detectors Pro* software or the HART master system to deactivate the analogue signal.

8.5 Functions available via HART

- Gas concentration display
- Obscuration level display (for IR sensors)
- Supply voltage display
- Sensor and Transmitter temperature display
- Alarm/Relay status
- Calibration/Bump Test due dates
- Output signal trim and ramp
- Real time clock set
- Detector reset function
- Sensor range adjustment
- Select/deselect Inhibit mode
- Sensor Zero, Calibration and Bump Test
- Transmitter and Sensor Module serial number display
- Software version display
- Display and change HART password
- Read and adjust alarm thresholds
- Detailed Positive Safety/Warning/Fault status information.
- Configuration display: Sensor type, Relay module fitted Y/N.

A specific DD (Device Description) file must be loaded into a HART communicator or controller to enable an interface with **XgardIQ**.

A detailed 'XgardIQ HART Instructions' document is available containing all of the information necessary to compile a suitable HART software interface. This document can be downloaded from:

www.crowcon.com/uk/products/fixed-detectors/xgardiq.html

For further information on HART, and to access and upload instrument DD (Device Description) files visit:

www.hartcomm.org

HART is a registered trademark of the HART Communication Foundation.

Note: Event-log data cannot be uploaded via HART; only via Crowcon's Detectors Pro software.

9. Functional Safety Manual

9.1 Introduction

The following sections provide detail on the certification of **XgardIQ** in accordance with the IEC 61508 and EN 50402 Functional Safety standards. Information is given on the features considered in the safety case, maintenance requirements and data to enable **XgardIQ** to be integrated into Safety Instrumented System (SIS).

9.2 XgardIQ Safety Function

To measure the concentration of flammable, toxic or oxygen gas and indicate the measurement by means of a 4-20mA output.

Failures in respect of the safety function will be detected by the hardware and associated firmware. They will be revealed as an output signal of less than 3.6mA or more than 21mA.

Where a relay module is fitted, failures in respect of the safety function will be revealed via the Fault relay contact.

Alarm conditions will be revealed via a proportional analogue output signal in the range 4-20mA.

Where a relay module is fitted, alarm conditions will be revealed via the alarm 1 and Alarm 2 relay contacts.

The **XgardIQ** display function, RS-485 Modbus function and HART communications function are excluded from the functional safety assessment.

9.3 Diagnostic Interval

Diagnostic functions are continuously monitored.

The system Watchdog must be tested during the annual proof test: **XgardIQ** must be re-started using the Watchdog function (refer to page 33), or power-cycled, annually as part of the maintenance programme.

9.4 Constraints

Failure rates are constant.

A proof test conducted at least once a year will identify all un-revealed failures.

Repairs have a mean time to repair of 8 hours; this assumes that a trained and competent engineer, and spare parts are available locally.

It is assumed that the user makes use of that diagnostic facility provided via the OLED Display and/or PC interface in order to minimise potential product down time.

Reliability assessment is a statistical process for applying historical failure data to proposed designs and configurations. It therefore provides a credible target/estimate of the likely reliability of equipment assuming manufacturing, design and operating conditions identical to those under which the data was collected. It is a valuable design review technique for comparing alternative designs, establishing order of magnitude performance targets and evaluating the potential effects of design changes. The actual predicted values cannot, however, be guaranteed as forecasting the precise number of field failures which will actually occur, since this depends on many factors outside the control of a predictive exercise.

Failure rates (symbol λ), for the purpose of this prediction, are assumed to be constant with time. Both early and wear-out related failures would decrease the reliability but are assumed to be removed by burn in and preventive replacement respectively.

9.5 Fault indication whilst in Inhibit mode

The functional safety standard EN50402:2010 stipulates that any "special state" (eg detector inhibited) should be indicated by an output relay. For compliance with the standard the Fault relay must activate when the detector is in zero/calibration or bump test mode (or manually placed into inhibit). This functionality is provided only when the appropriate tick box is checked using the Detectors Pro software. By default detectors will be configured so that the Fault relay (where fitted) does not operate as described above (ie is not EN50402 compliant).

Contact Crowcon for functional safety data.

Warranty

Equipment leaving our works are fully tested and/or calibrated. If within the warranty period of **3 years** from despatch, the **XgardIQ** transmitter is proved to be defective by reason of faulty workmanship or material, we undertake at our discretion either to repair or replace it free of charge, subject to the conditions below. Sensor module warranty periods are stipulated on the specification sheet supplied with the module.

Warranty Procedure

To facilitate efficient processing of any claim, contact our customer support team on 01235 557711 or customersupport@crowcon.com with the following information:

To return the faulty goods you will need to obtain a Customer Returns number (CRN) for identification and traceability purposes. Send in a completed Warranty Claim form to the above email address to receive a CRN reference to return the goods against, a copy of the form may be downloaded from our website www.crowcon.com on the Download section of the Support page or alternatively we can 'email' you a copy from the email address above.

Follow the instructions on the form please ensure you provide the following details:

- Company name, your contact name, phone number, and email address as well as your return address
- Product type, Part Number, Description, Quantity, Instrument serial number(s), reported fault as per the form
- When returning the goods please also detail any included accessories.

Instruments will not be accepted for warranty without a Crowcon Returns Number ("CRN"). It is essential that the address label is securely attached to the outer packaging of the returned goods and the CRN reference is clearly identifiable on this label as well as your returns paper work.

Warranty Disclaimer

The guarantee will be rendered invalid if the instrument is found to have been altered, modified, dismantled, or tampered with. Any service by 3rd parties not authorized & certified by **Crowcon** will invalidate the warranty on the equipment. Use of alternative manufacturer's sensors which have not been approved by **Crowcon** will invalidate the warranty of the product as a whole. The warranty does not cover misuse or abuse of the unit.

Any warranty on batteries may be rendered invalid if an unreasonable charging regime is proven.

Sensor types have individually defined warranty periods which can differ from the hardware warranty period. **Crowcon** reserve the right to amend warranty periods for particular applications. Sensor warranty is rendered invalid if the sensors have been exposed to excessive concentrations of gas, extended periods of exposure to gas or have been exposed to 'poisons' that can damage the sensor, such as those emitted by aerosol sprays.

Additionally see the Warranty Returns statement attached to Warranty Claim Form.

Units returned to **Crowcon** as faulty and are subsequently found to be 'fault free' or requiring service, may be subject to a handling, service and carriage charge.

Repair Warranty

Product repairs within the warranty period will be free of charge for both labour and parts. Should a full service / calibration also be due, then this is agreed with the customer to be carried out at the same time as the repair and the service element will be chargeable.

Warranty replaced parts will usually carry a further 12 month warranty at **Crowcon's** discretion up to the warranty of the original instrument being repaired (sensor exclusions are available from Customer Support at the email address above) for both parts and labour. Should a second but unrelated failure occur outside of the product warranty, this will be subject to separate charges.

Crowcon accept no liability for consequential or indirect loss or damage howsoever arising (including any loss or damage arising out of the use of the instrument) and all liability in respect of any third party is expressly excluded.

The warranty and guarantee does not cover the accuracy of the calibration of the unit or the cosmetic finish of the product. The unit must be maintained in accordance with the Operating and Maintenance Instructions.

Our liability in respect of defective equipment shall be limited to the obligations set out in the guarantee and any extended warranty, condition or statement, express or implied statutory or otherwise as to the merchantable quality of our equipment or its fitness for any particular purpose is excluded except as prohibited by statute. This guarantee shall not affect a customer's statutory rights.

Our postal address is:

Crowcon Detection Instruments Ltd. (UK Head Office)
172 Brook Drive
Milton Park
Oxfordshire
OX14 4SD



A HALMA COMPANY

UK Office

Crowcon Detection Instruments Ltd
172 Brook Drive,
Milton Park,
Abingdon
Oxfordshire
OX14 4SD

Tel: +44 (0)1235 557700

Fax: +44 (0)1235 557749

Email: sales@crowcon.com

Netherlands Office

Crowcon Detection Instruments Ltd
Vlambloem 129
3068JG, Rotterdam
Netherlands

Tel: +31 10 421 1232

Fax: +31 10 421 0542

Email: eu@crowcon.com

USA Office

Crowcon Detection Instruments Ltd
1455 Jamike Ave.
Suite 100
Erlanger
KY 41018

Tel: +1 859 957 1039 or
+1 800 527 6926

Fax: +1 859 957 1044

Email: salesusa@crowcon.com

Singapore Office

Crowcon Detection Instruments Ltd
Block 194, Pandan Loop
#06-20 Pantech Industrial Complex
Singapore 128383

Tel: +65 6745 2936

Fax: +65 6745 0467

Email: sales@crowcon.com.sg

China Office

Crowcon Detection Instruments Ltd (Beijing)
Unit 316, Area 1, Tower B,
Chuangxin Building,
12 Hongda North Road,
Beijing Economic & Technological
Development Area,
Beijing, China 100176

Tel: +86 10 6787 0335

Fax: +86 10 6787 4879

Email: saleschina@crowcon.com

Web site: www.crowcon.com